



## Inductive sensor NBB30-L2K-A2-V1

- 30 mm flush
- Active Shielding Technology
- 4-wire DC
- Sensor head bidirectional and rotatable
- Quick mounting bracket
- 4 LEDs indicator for 360° visibility



### Function

Inductive sensors with active shielding technology detect in addition to the damping element also the installation environment. As a result, they keep the operating distance constantly high, regardless of the installation situation and the installation material.

### Dimensions

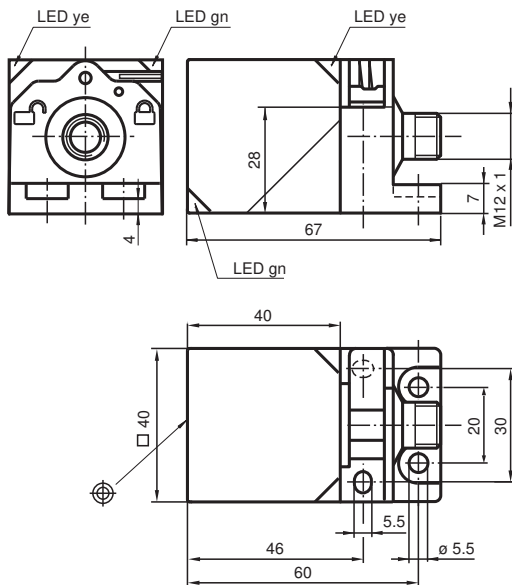

### Technical Data

#### General specifications

Switching function		complementary
Output type		PNP
Rated operating distance	$s_n$	30 mm
Installation		flush
Output polarity		DC
Assured operating distance	$s_a$	0 ... 24.3 mm
Actual operating distance	$s_r$	27 ... 33 mm typ.
Reduction factor $r_{AI}$		0.4
Reduction factor $r_{Cu}$		0.37

Release date: 2020-09-03 Date of issue: 2020-09-03 Filename: 316607-0009\_eng.pdf

Refer to "General Notes Relating to Pepperl+Fuchs Product Information".

Pepperl+Fuchs Group  
www.pepperl-fuchs.com

USA: +1 330 486 0001  
fa-info@us.pepperl-fuchs.com

Germany: +49 621 776 1111  
fa-info@de.pepperl-fuchs.com

Singapore: +65 6779 9091  
fa-info@sg.pepperl-fuchs.com

**PF** PEPPERL+FUCHS

## Technical Data

Reduction factor $r_{304}$		0.76
Reduction factor $r_{Brass}$		0.46
Output type		4-wire
<b>Nominal ratings</b>		
Operating voltage	$U_B$	10 ... 30 V DC
Switching frequency	$f$	0 ... 60 Hz
Hysteresis	$H$	typ. 2 %
Reverse polarity protection		reverse polarity protected
Short-circuit protection		pulsing
Voltage drop	$U_d$	$\leq 2$ V
Operating current	$I_L$	0 ... 200 mA
Off-state current	$I_r$	0 ... 0.5 mA
No-load supply current	$I_0$	$\leq 20$ mA
Time delay before availability	$t_v$	80 ms
Operating voltage indicator		LED, green
Switching state indicator		LED, yellow
<b>Functional safety related parameters</b>		
MTTF <sub>d</sub>		899 a
Mission Time ( $T_M$ )		20 a
Diagnostic Coverage (DC)		0 %
<b>Compliance with standards and directives</b>		
Standard conformity		
Standards		EN 60947-5-2:2007 EN 60947-5-2/A1:2012 IEC 60947-5-2:2007 IEC 60947-5-2 AMD 1:2012
<b>Approvals and certificates</b>		
UL approval		cULus Listed, General Purpose
CCC approval		CCC approval / marking not required for products rated $\leq 36$ V
<b>Ambient conditions</b>		
Ambient temperature		-25 ... 70 °C (-13 ... 158 °F)
Storage temperature		-40 ... 85 °C (-40 ... 185 °F)
<b>Mechanical specifications</b>		
Connection type		Connector plug M12 x 1 , 4-pin
Housing material		PA
Sensing face		PA
Degree of protection		IP68 / IP69
Mass		130 g

## Connection

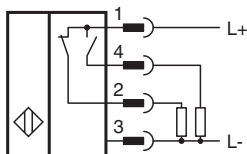



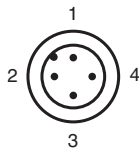

## Connection Assignment



Wire colors in accordance with EN 60947-5-2

1	BN	(brown)
2	WH	(white)
3	BU	(blue)
4	BK	(black)

## Accessories

	<b>V1-G-2M-PUR</b>	Female cordset, M12, 4-pin, PUR cable
	<b>V1-W-2M-PUR</b>	Female cordset, M12, 4-pin, PUR cable
	<b>MHW 01</b>	Modular mounting bracket
	<b>MH 02-L</b>	Mounting aid

Release date: 2020-09-03 Date of issue: 2020-09-03 Filename: 316607-0009\_eng.pdf

Refer to "General Notes Relating to Pepperl+Fuchs Product Information".