

Data Sheet | Item Number: 765-4103/100-000

4-Port IO-Link Master Class A; Profinet; DC 24 V / 2.0 A; 4xM12 connection; SlimLine

<https://www.wago.com/765-4103/100-000>

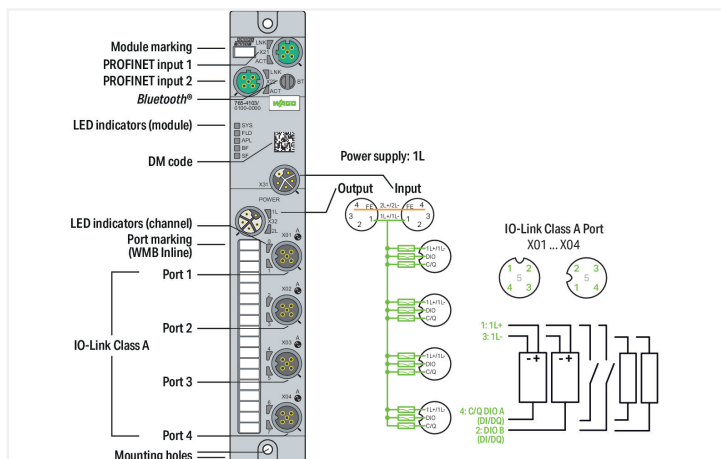

Application:
Decentralized processing of digital and IO-Link signals

This device records and controls IO-Link-capable digital field device signals (e.g., from sensors, actuators and hubs) that are received or controlled by a higher-level controller. The device is designed as a Class A master and offers four IO-Link ports or eight digital inputs/outputs.

IO-Link:
The device has several IO-Link communication interfaces for interoperability with IO-Link devices. The IO-Link interface enables direct access to the process and diagnostic data and allows the parameters of the connected devices to be set during operation. The IODD can also be <https://ioddfinder.io-link.com> downloaded via the IODDfinder.

Technical data

Fieldbus	
Communications	PROFINET PROFINET IO device; 2-port switch, LLDP, MRP, SNMP
Connection technology: communication/fieldbus	2 x D-coded M12; 4-pole
Interface standard	10BASE-T/100BASE-TX; potential-free
Autonegotiation; autocrossover	Yes
PROFINET IO features	PROFINET IO device; 2-port switch, LLDP, MRP, SNMP

Device functions	
Parameter	Input filter Output current Temperature
Diagnostics	Undervoltage; overcurrent; overload; overtemperature
Device functions	Bluetooth® OPC UA server
Visualization	Android/iOS app Web server

IO-Link master

IO-Link master classification	Class A; V1.1 specification
Port-Modus	IO-Link: autoconfig, manual, tool-based DI DO
Cycle time	400 µs (min.)
Operating mode	IO-Link master, DI or DO (adjustable for pin 4 per port); DI or DO (adjustable for pin 2 per port)

IO-Link ports

Number of digital inputs	8
Number of digital outputs	8
Connection technology: inputs/outputs	4 x A-coded M12; 5-pole
Signal type (voltage)	24 VDC
Input characteristic	high-side switching Type 3, per IEC 61131-2
Input filter	0.2 ... 20 ms
Output current (per channel)	2 A (typ.) for DO
Supply current per port	1L: 1 A for IO-Link; 4 A (max.) for DIO

Supply (module)

Connection technology: supply	2 x L-coded M12; 5-pole
Supply voltage	24 VDC (18 ... 31.2 V); 1L
Current consumption (max.)	16000 mA
Current consumption (note)	per supply line; overload- and short-circuit-protected
Reverse voltage protection	Yes

Physical data

Width	35 mm / 1.378 inches
Height	30 mm / 1.181 inches
Depth	210 mm / 8.268 inches

Mechanical data

Weight	380 g
Conformity marking	CE

Environmental requirements

Ambient temperature (operation)	-25 ... +70 °C
Ambient temperature (storage)	-40 ... +80 °C
Protection type	IP67
Protection class	III per EN 61140, IEC 61140, VDE 0140-1
Operating altitude	0 ... 2000 m / 0 ... 6562 ft
Pollution degree	3 (EN 60664-1)
Overvoltage category	II (EN 60664-1)
Relative humidity (without condensation)	95 %
Vibration resistance	5g per IEC 60068-2-6
Shock resistance	Short-term: 50g/11 ms/half-sine per IEC 60068-2-27; Long-term: 30g/6 ms/half-sine per IEC 60068-2-29
EMC immunity to interference	per EN 61000-6-2
EMC emission of interference	per EN 61000-6-4

Commercial data

ETIM 9.0	EC001601
ETIM 8.0	EC001601
PU (SPU)	1 pcs
Packaging type	Box
Country of origin	DE
GTIN	4055143950053
Customs tariff number	85371098990

Environmental Product Compliance

CAS-No.	7439-92-1
REACH Candidate List Substance	Lead
RoHS Compliance Status	Compliant,With Exemption
RoHS Exemption	6(c) 7(a) 7(c)-I
SCIP notification number (Austria)	86e87699-35bf-421b-aae9-82dfa4013485
SCIP notification number (Belgium)	db867a9a-f8d9-464d-ad64-a7a45495db04
SCIP notification number (Bulgaria)	4d9dd066-3b81-4cc7-9c00-c32ded3a83fb
SCIP notification number (Czech Republic)	04a03d94-5d26-4be8-b421-7bc9c7adb8a2
SCIP notification number (Denmark)	a87ca643-d3cf-485f-aa72-1a52aec17a37
SCIP notification number (Finland)	6ef3e993-1e42-4b23-9725-773c5f56216e
SCIP notification number (France)	cbf8b064-7389-4fb8-b8df-5cd045800397
SCIP notification number (Germany)	44226e4c-e4f7-4417-bc7f-57a58032c88e
SCIP notification number (Hungary)	0995f8de-e098-4508-b4f4-3d6b2c501a01
SCIP notification number (Italy)	f2a4bd3d-9539-49d1-afd0-cf6217f26009
SCIP notification number (Netherlands)	e8e40001-8450-40f0-be32-3d30a9fe503c
SCIP notification number (Poland)	2a59b41b-9b72-4fdc-ac41-5b7747f89246
SCIP notification number (Romania)	19b92347-ab32-4a6a-b4e1-95593e72449c
SCIP notification number (Sweden)	6151591a-75ce-4294-8411-cf77668fc4a2

Approvals / Certificates

General approvals



Approval	Standard	Certificate Name
EAC GZO Almaty Standart	TP TC 020/2011	EAC CoC 03083
KC National Radio Research Agency	Article 58-2, Clause 3	KC R-R-W43-FB765
UL Underwriters Laboratories Inc. (ORDINARY LOCATI- ONS)	-	E175199

Downloads

Environmental Product Compliance

Compliance Search

Environmental Product Compliance
765-4103/100-000



Documentation

Manual

Product Manual 4-Port IO-Link Master Class A; Profinet V 2.2.0 28.07.2022 pdf 8529.13 KB



System Description

WAGO I/O System Field; General Product Information pdf 1009.23 KB



Instruction Leaflet

I/O System Field package insert 15.12.2021 pdf 1083.98 KB



CAD/CAE-Data

CAD data

2D/3D Models
765-4103/100-000



CAE data

EPLAN Data Portal
765-4103/100-000



ZUKEN Portal
765-4103/100-000



Libraries

Device Description File

750-916; GSD files of version 2.x for PROFINET/ series 750/753, 765, 767 and 852 3.0 15.01.2023 zip 2582.40 KB



Gerätebeschreibungsdateien 765-41xx, 765-11xx, PROFINET V1_1_0_22 zip 27.85 KB



1 Compatible Products

1.1 Required Accessories

1.1.1 Cover

1.1.1.1 Cover



[Item No.: 756-8103](#)

M12 protective cap; for unused plugs

[Item No.: 756-8102](#)

M12 protective cap; for unused sockets

1.1.2 Marking

1.1.2.1 Marker



Item No.: 2009-115

WMB-Inline; for Smart Printer; 1500 pieces on roll; stretchable 5 - 5.2 mm; plain; snap-on type; white

1.1.2.2 Marking strip



Item No.: 2009-110

Marking strips; for Smart Printer; on reel; not stretchable; plain; snap-on type; white

1.1.3 Tool

1.1.3.1 Assembly tool



Item No.: 206-701

Torque wrench M8 and M12; Assembly kit

1.2 Optional Accessories

1.2.1 Cables and connectors

1.2.1.1 Adapter



Item No.: 756-9503/040-000

Accessories; 4-pole



Item No.: 756-9504/040-000

Accessories; 4-pole

1.2.1.2 Configurable Connector



Item No.: 756-9205/040-000

Fitted pluggable connector; 4-pole; M12 plug, right angle; Spring



Item No.: 756-9202/040-000

Fitted pluggable connector; 4-pole; M12 plug, straight, A-coded; Spring



Item No.: 756-9701/050-000

Fitted pluggable connector; 5-pole, shielded; M12 plug, straight; IDC technology



Item No.: 756-9711/050-000

Fitted pluggable connector; 5-pole, shielded; M12 socket, straight; IDC technology

1.2.1.3 Configurable Shielded Connector



Item No.: 756-9501/040-000

Accessories; M12 plug, right angle; 4-pole





















Item No.: 756-9501/060-000

Fitted pluggable connector; 4-pole, shielded; M12 plug, straight, D-coded; Spring













1.2.1.4 Distribution connector

 <p>Item No.: 756-9301/040-000 Accessories; 4-pole</p>	 <p>Item No.: 756-9301/050-000 Accessories; 5-pole</p>	 <p>Item No.: 756-5517/040-010 Sensor/Actuator cable; 2xM12 socket; angled; M12A plug; straight; 4-pole; Length: 1 m</p>	 <p>Item No.: 756-5517/040-020 Sensor/Actuator cable; 2xM12 socket; angled; M12A plug; straight; 4-pole; Length: 2 m</p>
 <p>Item No.: 756-5516/040-010 Sensor/Actuator cable; 2xM12 socket; straight; M12A plug; straight; 4-pole; Length: 1 m</p>	 <p>Item No.: 756-5516/040-020 Sensor/Actuator cable; 2xM12 socket; straight; M12A plug; straight; 4-pole; Length: 2 m</p>	 <p>Item No.: 756-5514/040-010 Sensor/Actuator cable; 2xM8 socket; angled; M12A plug; straight; 4-pole; Length: 1 m</p>	 <p>Item No.: 756-5514/040-020 Sensor/Actuator cable; 2xM8 socket; angled; M12A plug; straight; 4-pole; Length: 2 m</p>
 <p>Item No.: 756-5513/040-010 Sensor/Actuator cable; 2xM8 socket; straight; M12A plug; straight; 4-pole; Length: 1 m</p>	 <p>Item No.: 756-5513/040-020 Sensor/Actuator cable; 2xM8 socket; straight; M12A plug; straight; 4-pole; Length: 2 m</p>		







































1.2.1.5 ETHERNET/PROFINET cable

 <p>Item No.: 756-1202/060-100 ETHERNET cable; M12D plug; angled; 4-pole; Length: 10 m</p>	 <p>Item No.: 756-1202/060-020 ETHERNET cable; M12D plug; angled; 4-pole; Length: 2 m</p>	 <p>Item No.: 756-1202/060-200 ETHERNET cable; M12D plug; angled; 4-pole; Length: 20 m</p>	 <p>Item No.: 756-1202/060-050 ETHERNET cable; M12D plug; angled; 4-pole; Length: 5 m</p>
 <p>Item No.: 756-1204/060-010 ETHERNET cable; M12D plug; angled; M12D plug; angled; 4-pole; Length: 1 m</p>	 <p>Item No.: 756-1204/060-100 ETHERNET cable; M12D plug; angled; M12D plug; angled; 4-pole; Length: 10 m</p>	 <p>Item No.: 756-1204/060-020 ETHERNET cable; M12D plug; angled; M12D plug; angled; 4-pole; Length: 2 m</p>	 <p>Item No.: 756-1204/060-200 ETHERNET cable; M12D plug; angled; M12D plug; angled; 4-pole; Length: 20 m</p>
 <p>Item No.: 756-1204/060-030 ETHERNET cable; M12D plug; angled; M12D plug; angled; 4-pole; Length: 3 m</p>	 <p>Item No.: 756-1204/060-050 ETHERNET cable; M12D plug; angled; M12D plug; angled; 4-pole; Length: 5 m</p>	 <p>Item No.: 756-1201/060-100 ETHERNET cable; M12D plug; straight; 4-pole; Length: 10 m</p>	 <p>Item No.: 756-1201/060-020 ETHERNET cable; M12D plug; straight; 4-pole; Length: 2 m</p>
 <p>Item No.: 756-1201/060-200 ETHERNET cable; M12D plug; straight; 4-pole; Length: 20 m</p>	 <p>Item No.: 756-1201/060-050 ETHERNET cable; M12D plug; straight; 4-pole; Length: 5 m</p>	 <p>Item No.: 756-1203/060-100 ETHERNET cable; M12D plug; straight; M12D plug; straight; 4-pole; Length: 10 m</p>	 <p>Item No.: 756-1203/060-020 ETHERNET cable; M12D plug; straight; M12D plug; straight; 4-pole; Length: 2 m</p>
 <p>Item No.: 756-1203/060-200 ETHERNET cable; M12D plug; straight; M12D plug; straight; 4-pole; Length: 20 m</p>	 <p>Item No.: 756-1203/060-050 ETHERNET cable; M12D plug; straight; M12D plug; straight; 4-pole; Length: 5 m</p>		

1.2.1.6 Power cable

 <p>Item No.: 756-3504/050-100 Power cable; M12L plug; angled; 5-pole; Length: 10 m</p>	 <p>Item No.: 756-3514/050-100 Power cable; M12L plug; angled; 5-pole; Length: 10 m</p>	 <p>Item No.: 756-3504/050-150 Power cable; M12L plug; angled; 5-pole; Length: 15 m</p>	 <p>Item No.: 756-3514/050-150 Power cable; M12L plug; angled; 5-pole; Length: 15 m</p>
 <p>Item No.: 756-3504/050-020 Power cable; M12L plug; angled; 5-pole; Length: 2 m</p>	 <p>Item No.: 756-3504/050-050 Power cable; M12L plug; angled; 5-pole; Length: 5 m</p>	 <p>Item No.: 756-3514/050-050 Power cable; M12L plug; angled; 5-pole; Length: 5 m</p>	 <p>Item No.: 756-3504/050-075 Power cable; M12L plug; angled; 5-pole; Length: 7.5 m</p>
 <p>Item No.: 756-3514/050-075 Power cable; M12L plug; angled; 5-pole; Length: 7.5 m</p>	 <p>Item No.: 756-3503/050-100 Power cable; M12L plug; straight; 5-pole; Length: 10 m</p>	 <p>Item No.: 756-3513/050-100 Power cable; M12L plug; straight; 5-pole; Length: 10 m</p>	 <p>Item No.: 756-3503/050-150 Power cable; M12L plug; straight; 5-pole; Length: 15 m</p>

1.2.1.6 Power cable

 Item No.: 756-3513/050-150 Power cable; M12L plug; straight; 5-pole; Length: 15 m	 Item No.: 756-3503/050-020 Power cable; M12L plug; straight; 5-pole; Length: 2 m	 Item No.: 756-3513/050-020 Power cable; M12L plug; straight; 5-pole; Length: 2 m	 Item No.: 756-3503/050-050 Power cable; M12L plug; straight; 5-pole; Length: 5 m
 Item No.: 756-3513/050-050 Power cable; M12L plug; straight; 5-pole; Length: 5 m	 Item No.: 756-3503/050-075 Power cable; M12L plug; straight; 5-pole; Length: 7.5 m	 Item No.: 756-3513/050-075 Power cable; M12L plug; straight; 5-pole; Length: 7.5 m	 Item No.: 756-3502/050-100 Power cable; M12L socket; angled; 5-pole; Length: 10 m
 Item No.: 756-3512/050-100 Power cable; M12L socket; angled; 5-pole; Length: 10 m	 Item No.: 756-3502/050-150 Power cable; M12L socket; angled; 5-pole; Length: 15 m	 Item No.: 756-3512/050-150 Power cable; M12L socket; angled; 5-pole; Length: 15 m	 Item No.: 756-3502/050-020 Power cable; M12L socket; angled; 5-pole; Length: 2 m
 Item No.: 756-3512/050-020 Power cable; M12L socket; angled; 5-pole; Length: 2 m	 Item No.: 756-3502/050-050 Power cable; M12L socket; angled; 5-pole; Length: 5 m	 Item No.: 756-3512/050-050 Power cable; M12L socket; angled; 5-pole; Length: 5 m	 Item No.: 756-3502/050-075 Power cable; M12L socket; angled; 5-pole; Length: 7.5 m
 Item No.: 756-3512/050-075 Power cable; M12L socket; angled; 5-pole; Length: 7.5 m	 Item No.: 756-3506/050-003 Power cable; M12L socket; angled; M12L plug; angled; 5-pole; Length: 0.3 m	 Item No.: 756-3506/050-005 Power cable; M12L socket; angled; M12L plug; angled; 5-pole; Length: 0.5 m	 Item No.: 756-3516/050-005 Power cable; M12L socket; angled; M12L plug; angled; 5-pole; Length: 0.5 m
 Item No.: 756-3506/050-010 Power cable; M12L socket; angled; M12L plug; angled; 5-pole; Length: 1 m	 Item No.: 756-3516/050-010 Power cable; M12L socket; angled; M12L plug; angled; 5-pole; Length: 1 m	 Item No.: 756-3506/050-100 Power cable; M12L socket; angled; M12L plug; angled; 5-pole; Length: 10 m	 Item No.: 756-3516/050-100 Power cable; M12L socket; angled; M12L plug; angled; 5-pole; Length: 10 m
 Item No.: 756-3506/050-150 Power cable; M12L socket; angled; M12L plug; angled; 5-pole; Length: 15 m	 Item No.: 756-3506/050-020 Power cable; M12L socket; angled; M12L plug; angled; 5-pole; Length: 2 m	 Item No.: 756-3516/050-020 Power cable; M12L socket; angled; M12L plug; angled; 5-pole; Length: 2 m	 Item No.: 756-3516/050-200 Power cable; M12L socket; angled; M12L plug; angled; 5-pole; Length: 20 m
 Item No.: 756-3516/050-400 Power cable; M12L socket; angled; M12L plug; angled; 5-pole; Length: 40 m	 Item No.: 756-3506/050-050 Power cable; M12L socket; angled; M12L plug; angled; 5-pole; Length: 5 m	 Item No.: 756-3516/050-050 Power cable; M12L socket; angled; M12L plug; angled; 5-pole; Length: 5 m	 Item No.: 756-3506/050-075 Power cable; M12L socket; angled; M12L plug; angled; 5-pole; Length: 7.5 m
 Item No.: 756-3516/050-075 Power cable; M12L socket; angled; M12L plug; angled; 5-pole; Length: 7.5 m	 Item No.: 756-3501/050-100 Power cable; M12L socket; straight; 5-pole; Length: 10 m	 Item No.: 756-3511/050-100 Power cable; M12L socket; straight; 5-pole; Length: 10 m	 Item No.: 756-3501/050-150 Power cable; M12L socket; straight; 5-pole; Length: 15 m
 Item No.: 756-3511/050-150 Power cable; M12L socket; straight; 5-pole; Length: 15 m	 Item No.: 756-3501/050-020 Power cable; M12L socket; straight; 5-pole; Length: 2 m	 Item No.: 756-3511/050-020 Power cable; M12L socket; straight; 5-pole; Length: 2 m	 Item No.: 756-3501/050-050 Power cable; M12L socket; straight; 5-pole; Length: 5 m
 Item No.: 756-3511/050-050 Power cable; M12L socket; straight; 5-pole; Length: 5 m	 Item No.: 756-3501/050-075 Power cable; M12L socket; straight; 5-pole; Length: 7.5 m	 Item No.: 756-3511/050-075 Power cable; M12L socket; straight; 5-pole; Length: 7.5 m	 Item No.: 756-3505/050-003 Power cable; M12L socket; straight; M12L plug; straight; 5-pole; Length: 0.3 m
 Item No.: 756-3505/050-005 Power cable; M12L socket; straight; M12L plug; straight; 5-pole; Length: 0.5 m	 Item No.: 756-3515/050-005 Power cable; M12L socket; straight; M12L plug; straight; 5-pole; Length: 0.5 m	 Item No.: 756-3505/050-010 Power cable; M12L socket; straight; M12L plug; straight; 5-pole; Length: 1 m	 Item No.: 756-3515/050-010 Power cable; M12L socket; straight; M12L plug; straight; 5-pole; Length: 1 m
 Item No.: 756-3505/050-100 Power cable; M12L socket; straight; M12L plug; straight; 5-pole; Length: 10 m	 Item No.: 756-3515/050-100 Power cable; M12L socket; straight; M12L plug; straight; 5-pole; Length: 10 m	 Item No.: 756-3505/050-150 Power cable; M12L socket; straight; M12L plug; straight; 5-pole; Length: 15 m	 Item No.: 756-3505/050-020 Power cable; M12L socket; straight; M12L plug; straight; 5-pole; Length: 2 m

1.2.1.6 Power cable



Item No.: 756-3515/050-020

Power cable; M12L socket; straight; M12L plug; straight; 5-pole; Length: 2 m

Item No.: 756-3515/050-200

Power cable; M12L socket; straight; M12L plug; straight; 5-pole; Length: 20 m

Item No.: 756-3515/050-300

Power cable; M12L socket; straight; M12L plug; straight; 5-pole; Length: 30 m

Item No.: 756-3515/050-400

Power cable; M12L socket; straight; M12L plug; straight; 5-pole; Length: 40 m



Item No.: 756-3505/050-050

Power cable; M12L socket; straight; M12L plug; straight; 5-pole; Length: 5 m

Item No.: 756-3515/050-050

Power cable; M12L socket; straight; M12L plug; straight; 5-pole; Length: 5 m

Item No.: 756-3505/050-075

Power cable; M12L socket; straight; M12L plug; straight; 5-pole; Length: 7.5 m

Item No.: 756-3515/050-075

Power cable; M12L socket; straight; M12L plug; straight; 5-pole; Length: 7.5 m

1.2.1.7 Sensor/actuator cable



Item No.: 756-5312/040-015

Sensor/Actuator cable; M12A plug; angled; 4-pole; Length: 1.5 m

Item No.: 756-5312/040-100

Sensor/Actuator cable; M12A plug; angled; 4-pole; Length: 10 m

Item No.: 756-5312/040-050

Sensor/Actuator cable; M12A plug; angled; 4-pole; Length: 5 m

Item No.: 756-5311/040-015

Sensor/Actuator cable; M12A plug; straight; 4-pole; Length: 1.5 m



Item No.: 756-5311/040-100

Sensor/Actuator cable; M12A plug; straight; 4-pole; Length: 10 m

Item No.: 756-5311/040-050

Sensor/Actuator cable; M12A plug; straight; 4-pole; Length: 5 m

Item No.: 756-5404/040-010

Sensor/Actuator cable; M12A socket; straight; M12A plug; angled; 4-pole; Length: 1 m

Item No.: 756-5404/040-020

Sensor/Actuator cable; M12A socket; angled; M12A plug; angled; 4-pole; Length: 2 m



Item No.: 756-5403/040-010

Sensor/Actuator cable; M12A socket; angled; M12A plug; straight; 4-pole; Length: 1 m

Item No.: 756-5403/040-020

Sensor/Actuator cable; M12A socket; angled; M12A plug; straight; 4-pole; Length: 2 m

Item No.: 756-5402/040-010

Sensor/Actuator cable; M12A socket; straight; M12A plug; angled; 4-pole; Length: 1 m

Item No.: 756-5402/040-020

Sensor/Actuator cable; M12A socket; straight; M12A plug; angled; 4-pole; Length: 2 m



Item No.: 756-5401/040-010

Sensor/Actuator cable; M12A socket; straight; M12A plug; straight; 4-pole; Length: 1 m

Item No.: 756-5401/040-020

Sensor/Actuator cable; M12A socket; straight; M12A plug; straight; 4-pole; Length: 2 m

Item No.: 756-5510/040-010

Sensor/Actuator cable; M8 socket; angled; M12A plug; angled; 4-pole; Length: 1 m

Item No.: 756-5510/040-020

Sensor/Actuator cable; M8 socket; angled; M12A plug; angled; 4-pole; Length: 2 m



Item No.: 756-5509/040-010

Sensor/Actuator cable; M8 socket; angled; M12A plug; straight; 4-pole; Length: 1 m

Item No.: 756-5509/040-020

Sensor/Actuator cable; M8 socket; angled; M12A plug; straight; 4-pole; Length: 2 m

Item No.: 756-5508/040-010

Sensor/Actuator cable; M8 socket; straight; M12A plug; angled; 4-pole; Length: 1 m

Item No.: 756-5508/040-020

Sensor/Actuator cable; M8 socket; straight; M12A plug; angled; 4-pole; Length: 2 m



Item No.: 756-5507/040-010

Sensor/Actuator cable; M8 socket; straight; M12A plug; straight; 4-pole; Length: 1 m

Item No.: 756-5507/040-020

Sensor/Actuator cable; M8 socket; straight; M12A plug; straight; 4-pole; Length: 2 m