

# Data Sheet | Item Number: 765-4101/100-000

8-Port IO-Link Master Class A; Profinet; DC 24 V / 2.0 A; 8xM12 connection; WideLine

<https://www.wago.com/765-4101/100-000>

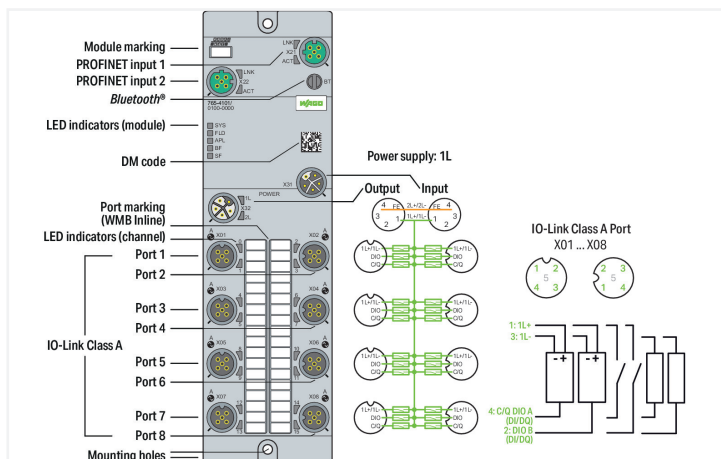

**Application:**  
Decentralized processing of digital and IO-Link signals

This device records and controls IO-Link-capable digital field device signals (e.g., from sensors, actuators and hubs) that are received or controlled by a higher-level controller. The device is designed as a Class A master and offers eight IO-Link ports or 16 digital inputs/outputs.

**IO-Link:**  
The device has several IO-Link communication interfaces for interoperation with IO-Link devices. The IO-Link interface enables direct access to the process and diagnostic data and allows the parameters of the connected devices to be set during operation. The IODD can also be <https://ioddfinder.io-link.com> downloaded via the IODDfinder.

## Technical data

Fieldbus	
Communications	PROFINET PROFINET IO device; 2-port switch, LLDP, MRP, SNMP
Connection technology: communication/fieldbus	2 x D-coded M12; 4-pole
Interface standard	10BASE-T/100BASE-TX; potential-free
Autonegotiation; autocrossover	Yes
PROFINET IO features	PROFINET IO device; 2-port switch, LLDP, MRP, SNMP

Device functions	
Parameter	Input filter Output current Temperature
Diagnostics	Undervoltage; overcurrent; overload; overtemperature
Device functions	Bluetooth® OPC UA server
Visualization	Android/iOS app Web server

### IO-Link master

IO-Link master classification	Class A; V1.1 specification
Port-Modus	IO-Link: autoconfig, manual, tool-based DI DO
Cycle time	400 µs (min.)
Operating mode	IO-Link master, DI or DO (adjustable for pin 4 per port); DI or DO (adjustable for pin 2 per port)

### IO-Link ports

Number of digital inputs	16
Number of digital outputs	16
Connection technology: inputs/outputs	8 x A-coded M12; 5-pole
Signal type (voltage)	24 VDC
Input characteristic	high-side switching Type 3, per IEC 61131-2
Input filter	0.2 ... 20 ms
Output current (per channel)	2 A (typ.) for DO
Supply current per port	1L: 1 A for IO-Link; 4 A (max.) for DIO

### Supply (module)

Connection technology: supply	2 x L-coded M12; 5-pole
Supply voltage	24 VDC (18 ... 31.2 V); 1L
Current consumption (max.)	16000 mA
Current consumption (note)	per supply line; overload- and short-circuit-protected
Reverse voltage protection	Yes

### Physical data

Width	60 mm / 2.362 inches
Height	30 mm / 1.181 inches
Depth	210 mm / 8.268 inches

### Mechanical data

Weight	610 g
Conformity marking	CE

### Environmental requirements

Ambient temperature (operation)	-25 ... +70 °C
Ambient temperature (storage)	-40 ... +80 °C
Protection type	IP67
Protection class	III per EN 61140, IEC 61140, VDE 0140-1
Operating altitude	0 ... 2000 m / 0 ... 6562 ft
Pollution degree	3 (EN 60664-1)
Overvoltage category	II (EN 60664-1)
Relative humidity (without condensation)	95 %
Vibration resistance	5g per IEC 60068-2-6
Shock resistance	Short-term: 50g/11 ms/half-sine per IEC 60068-2-27; Long-term: 30g/6 ms/half-sine per IEC 60068-2-29
EMC immunity to interference	per EN 61000-6-2
EMC emission of interference	per EN 61000-6-4

**Commercial data**

ETIM 9.0	EC001601
ETIM 8.0	EC001601
PU (SPU)	1 pcs
Packaging type	Box
Country of origin	DE
GTIN	4055143949996
Customs tariff number	85371098990

**Environmental Product Compliance**

CAS-No.	7439-92-1
REACH Candidate List Substance	Lead
RoHS Compliance Status	Compliant,With Exemption
RoHS Exemption	6(c) 7(a) 7(c)-I
SCIP notification number (Austria)	3d1b5f75-0483-45fd-94ce-081697512ae4
SCIP notification number (Belgium)	2345134c-9018-4565-95d4-8989d408f3d5
SCIP notification number (Bulgaria)	3ebe2820-3366-4690-b9b3-41b90079f1b9
SCIP notification number (Czech Republic)	94b741cb-a59a-4c93-ab8e-fe235a561502
SCIP notification number (Denmark)	0adc9ac4-e60d-46c0-bfa9-6e30b0c06044
SCIP notification number (Finland)	d26c4196-9345-490c-bc64-07e80b4d51b5
SCIP notification number (France)	f1567d28-637b-4580-b962-7fc67b19afd7
SCIP notification number (Germany)	ec77edca-13ab-40d1-b1c0-987ff3355111
SCIP notification number (Hungary)	2869872b-f535-42f4-847c-eceb43f0a0c2
SCIP notification number (Italy)	f95be9a8-4689-407b-89d1-1a535a82b8bc
SCIP notification number (Netherlands)	46e786b0-3e2d-435a-b6e6-33f69ba20460
SCIP notification number (Poland)	2bd9299e-30d5-4051-bc95-7c46764e5617
SCIP notification number (Romania)	b8658276-5634-4d52-a5a9-4159c451ac9a
SCIP notification number (Sweden)	b3ad0cc5-fb1c-4cef-8923-368ed8406760

**Approvals / Certificates**

**General approvals** **Declarations of conformity and manufacturer's declarations**



Approval	Standard	Certificate Name
EAC GZO Almaty Standart	TP TC 020/2011	EAC CoC 03083
KC National Radio Research Agency	Article 58-2, Clause 3	KC R-R-W43-FB765
UL Underwriters Laboratories Inc. (ORDINARY LOCATIONS)	-	E175199

Approval	Standard	Certificate Name
EU-Declaration of Conformity WAGO GmbH & Co. KG	-	-

**Downloads**

**Environmental Product Compliance**

**Compliance Search**

Environmental Product Compliance 765-4101/100-000	<a href="#">↓</a>
--	-------------------

**Documentation**

Manual			
Product Manual 8-Port IO-Link Master Class A; Profinet	V 2.2.0 19.07.2022	pdf 9248.50 KB	<a href="#">↓</a>

System Description		
WAGO I/O System Field; General Product Information	pdf 1009.23 KB	<a href="#">↓</a>

**Instruction Leaflet**

I/O System Field package insert	15.12.2021	pdf 1083.98 KB	<a href="#">↓</a>
---------------------------------	------------	-------------------	-------------------

**CAD/CAE-Data**

CAD data	
2D/3D Models 765-4101/100-000	<a href="#">↓</a>

CAE data	
EPLAN Data Portal 765-4101/100-000	<a href="#">↓</a>
ZUKEN Portal 765-4101/100-000	<a href="#">↓</a>

**Libraries**

Device Description File			
750-916; GSD files of version 2.x for PROFINET/ series 750/753, 765, 767 and 852	3.0 15.01.2023	zip 2582.40 KB	<a href="#">↓</a>
Gerätebeschreibungsdateien 765-41xx, 765-11xx, PROFINET	V1_1_0_22	zip 27.85 KB	<a href="#">↓</a>

**1 Compatible Products**

**1.1 Required Accessories**

**1.1.1 Cover**

**1.1.1.1 Cover**



[Item No.: 756-8103](#)  
M12 protective cap; for unused plugs

[Item No.: 756-8102](#)  
M12 protective cap; for unused sockets

## 1.1.2 Marking

### 1.1.2.1 Marker



**Item No.: 2009-115**

WMB-Inline; for Smart Printer; 1500 pieces on roll; stretchable 5 - 5.2 mm; plain; snap-on type; white

### 1.1.2.2 Marking strip



**Item No.: 2009-110**

Marking strips; for Smart Printer; on reel; not stretchable; plain; snap-on type; white

## 1.1.3 Tool

### 1.1.3.1 Assembly tool



**Item No.: 206-701**

Torque wrench M8 and M12; Assembly kit

## 1.2 Optional Accessories

### 1.2.1 Cables and connectors

#### 1.2.1.1 Adapter



**Item No.: 756-9503/040-000**

Accessories; 4-pole



**Item No.: 756-9504/040-000**

Accessories; 4-pole

#### 1.2.1.2 Configurable Connector



**Item No.: 756-9205/040-000**

Fitted pluggable connector; 4-pole; M12 plug, right angle; Spring



**Item No.: 756-9202/040-000**

Fitted pluggable connector; 4-pole; M12 plug, straight, A-coded; Spring



**Item No.: 756-9701/050-000**

Fitted pluggable connector; 5-pole, shielded; M12 plug, straight; IDC technology



**Item No.: 756-9711/050-000**

Fitted pluggable connector; 5-pole, shielded; M12 socket, straight; IDC technology

#### 1.2.1.3 Configurable Shielded Connector



**Item No.: 756-9501/040-000**

Accessories; M12 plug, right angle; 4-pole





















**Item No.: 756-9501/060-000**

Fitted pluggable connector; 4-pole, shielded; M12 plug, straight, D-coded; Spring













1.2.1.4 Distribution connector

 <p><b>Item No.: 756-9301/040-000</b> Accessories; 4-pole</p>	 <p><b>Item No.: 756-9301/050-000</b> Accessories; 5-pole</p>	 <p><b>Item No.: 756-5517/040-010</b> Sensor/Actuator cable; 2xM12 socket; angled; M12A plug; straight; 4-pole; Length: 1 m</p>	 <p><b>Item No.: 756-5517/040-020</b> Sensor/Actuator cable; 2xM12 socket; angled; M12A plug; straight; 4-pole; Length: 2 m</p>
 <p><b>Item No.: 756-5516/040-010</b> Sensor/Actuator cable; 2xM12 socket; straight; M12A plug; straight; 4-pole; Length: 1 m</p>	 <p><b>Item No.: 756-5516/040-020</b> Sensor/Actuator cable; 2xM12 socket; straight; M12A plug; straight; 4-pole; Length: 2 m</p>	 <p><b>Item No.: 756-5514/040-010</b> Sensor/Actuator cable; 2xM8 socket; angled; M12A plug; straight; 4-pole; Length: 1 m</p>	 <p><b>Item No.: 756-5514/040-020</b> Sensor/Actuator cable; 2xM8 socket; angled; M12A plug; straight; 4-pole; Length: 2 m</p>
 <p><b>Item No.: 756-5513/040-010</b> Sensor/Actuator cable; 2xM8 socket; straight; M12A plug; straight; 4-pole; Length: 1 m</p>	 <p><b>Item No.: 756-5513/040-020</b> Sensor/Actuator cable; 2xM8 socket; straight; M12A plug; straight; 4-pole; Length: 2 m</p>		

1.2.1.5 ETHERNET/PROFINET cable

 <p><b>Item No.: 756-1202/060-100</b> ETHERNET cable; M12D plug; angled; 4-pole; Length: 10 m</p>	 <p><b>Item No.: 756-1202/060-020</b> ETHERNET cable; M12D plug; angled; 4-pole; Length: 2 m</p>	 <p><b>Item No.: 756-1202/060-200</b> ETHERNET cable; M12D plug; angled; 4-pole; Length: 20 m</p>	 <p><b>Item No.: 756-1202/060-050</b> ETHERNET cable; M12D plug; angled; 4-pole; Length: 5 m</p>
 <p><b>Item No.: 756-1204/060-010</b> ETHERNET cable; M12D plug; angled; M12D plug; angled; 4-pole; Length: 1 m</p>	 <p><b>Item No.: 756-1204/060-100</b> ETHERNET cable; M12D plug; angled; M12D plug; angled; 4-pole; Length: 10 m</p>	 <p><b>Item No.: 756-1204/060-020</b> ETHERNET cable; M12D plug; angled; M12D plug; angled; 4-pole; Length: 2 m</p>	 <p><b>Item No.: 756-1204/060-200</b> ETHERNET cable; M12D plug; angled; M12D plug; angled; 4-pole; Length: 20 m</p>
 <p><b>Item No.: 756-1204/060-030</b> ETHERNET cable; M12D plug; angled; M12D plug; angled; 4-pole; Length: 3 m</p>	 <p><b>Item No.: 756-1204/060-050</b> ETHERNET cable; M12D plug; angled; M12D plug; angled; 4-pole; Length: 5 m</p>	 <p><b>Item No.: 756-1201/060-100</b> ETHERNET cable; M12D plug; straight; 4-pole; Length: 10 m</p>	 <p><b>Item No.: 756-1201/060-020</b> ETHERNET cable; M12D plug; straight; 4-pole; Length: 2 m</p>
 <p><b>Item No.: 756-1201/060-200</b> ETHERNET cable; M12D plug; straight; 4-pole; Length: 20 m</p>	 <p><b>Item No.: 756-1201/060-050</b> ETHERNET cable; M12D plug; straight; 4-pole; Length: 5 m</p>	 <p><b>Item No.: 756-1203/060-100</b> ETHERNET cable; M12D plug; straight; M12D plug; straight; 4-pole; Length: 10 m</p>	 <p><b>Item No.: 756-1203/060-020</b> ETHERNET cable; M12D plug; straight; M12D plug; straight; 4-pole; Length: 2 m</p>
 <p><b>Item No.: 756-1203/060-200</b> ETHERNET cable; M12D plug; straight; M12D plug; straight; 4-pole; Length: 20 m</p>	 <p><b>Item No.: 756-1203/060-050</b> ETHERNET cable; M12D plug; straight; M12D plug; straight; 4-pole; Length: 5 m</p>		

1.2.1.6 Power cable

 <p><b>Item No.: 756-3504/050-100</b> Power cable; M12L plug; angled; 5-pole; Length: 10 m</p>	 <p><b>Item No.: 756-3514/050-100</b> Power cable; M12L plug; angled; 5-pole; Length: 10 m</p>	 <p><b>Item No.: 756-3504/050-150</b> Power cable; M12L plug; angled; 5-pole; Length: 15 m</p>	 <p><b>Item No.: 756-3514/050-150</b> Power cable; M12L plug; angled; 5-pole; Length: 15 m</p>
 <p><b>Item No.: 756-3504/050-020</b> Power cable; M12L plug; angled; 5-pole; Length: 2 m</p>	 <p><b>Item No.: 756-3504/050-050</b> Power cable; M12L plug; angled; 5-pole; Length: 5 m</p>	 <p><b>Item No.: 756-3514/050-050</b> Power cable; M12L plug; angled; 5-pole; Length: 5 m</p>	 <p><b>Item No.: 756-3504/050-075</b> Power cable; M12L plug; angled; 5-pole; Length: 7.5 m</p>
 <p><b>Item No.: 756-3514/050-075</b> Power cable; M12L plug; angled; 5-pole; Length: 7.5 m</p>	 <p><b>Item No.: 756-3503/050-100</b> Power cable; M12L plug; straight; 5-pole; Length: 10 m</p>	 <p><b>Item No.: 756-3513/050-100</b> Power cable; M12L plug; straight; 5-pole; Length: 10 m</p>	 <p><b>Item No.: 756-3503/050-150</b> Power cable; M12L plug; straight; 5-pole; Length: 15 m</p>

1.2.1.6 Power cable

 <b>Item No.: 756-3513/050-150</b> Power cable; M12L plug; straight; 5-pole; Length: 15 m	 <b>Item No.: 756-3503/050-020</b> Power cable; M12L plug; straight; 5-pole; Length: 2 m	 <b>Item No.: 756-3513/050-020</b> Power cable; M12L plug; straight; 5-pole; Length: 2 m	 <b>Item No.: 756-3503/050-050</b> Power cable; M12L plug; straight; 5-pole; Length: 5 m
 <b>Item No.: 756-3513/050-050</b> Power cable; M12L plug; straight; 5-pole; Length: 5 m	 <b>Item No.: 756-3503/050-075</b> Power cable; M12L plug; straight; 5-pole; Length: 7.5 m	 <b>Item No.: 756-3513/050-075</b> Power cable; M12L plug; straight; 5-pole; Length: 7.5 m	 <b>Item No.: 756-3502/050-100</b> Power cable; M12L socket; angled; 5-pole; Length: 10 m
 <b>Item No.: 756-3512/050-100</b> Power cable; M12L socket; angled; 5-pole; Length: 10 m	 <b>Item No.: 756-3502/050-150</b> Power cable; M12L socket; angled; 5-pole; Length: 15 m	 <b>Item No.: 756-3512/050-150</b> Power cable; M12L socket; angled; 5-pole; Length: 15 m	 <b>Item No.: 756-3502/050-020</b> Power cable; M12L socket; angled; 5-pole; Length: 2 m
 <b>Item No.: 756-3512/050-020</b> Power cable; M12L socket; angled; 5-pole; Length: 2 m	 <b>Item No.: 756-3502/050-050</b> Power cable; M12L socket; angled; 5-pole; Length: 5 m	 <b>Item No.: 756-3512/050-050</b> Power cable; M12L socket; angled; 5-pole; Length: 5 m	 <b>Item No.: 756-3502/050-075</b> Power cable; M12L socket; angled; 5-pole; Length: 7.5 m
 <b>Item No.: 756-3512/050-075</b> Power cable; M12L socket; angled; 5-pole; Length: 7.5 m	 <b>Item No.: 756-3506/050-003</b> Power cable; M12L socket; angled; M12L plug; angled; 5-pole; Length: 0.3 m	 <b>Item No.: 756-3506/050-005</b> Power cable; M12L socket; angled; M12L plug; angled; 5-pole; Length: 0.5 m	 <b>Item No.: 756-3516/050-005</b> Power cable; M12L socket; angled; M12L plug; angled; 5-pole; Length: 0.5 m
 <b>Item No.: 756-3506/050-010</b> Power cable; M12L socket; angled; M12L plug; angled; 5-pole; Length: 1 m	 <b>Item No.: 756-3516/050-010</b> Power cable; M12L socket; angled; M12L plug; angled; 5-pole; Length: 1 m	 <b>Item No.: 756-3506/050-100</b> Power cable; M12L socket; angled; M12L plug; angled; 5-pole; Length: 10 m	 <b>Item No.: 756-3516/050-100</b> Power cable; M12L socket; angled; M12L plug; angled; 5-pole; Length: 10 m
 <b>Item No.: 756-3506/050-150</b> Power cable; M12L socket; angled; M12L plug; angled; 5-pole; Length: 15 m	 <b>Item No.: 756-3506/050-020</b> Power cable; M12L socket; angled; M12L plug; angled; 5-pole; Length: 2 m	 <b>Item No.: 756-3516/050-020</b> Power cable; M12L socket; angled; M12L plug; angled; 5-pole; Length: 2 m	 <b>Item No.: 756-3516/050-200</b> Power cable; M12L socket; angled; M12L plug; angled; 5-pole; Length: 20 m
 <b>Item No.: 756-3516/050-400</b> Power cable; M12L socket; angled; M12L plug; angled; 5-pole; Length: 40 m	 <b>Item No.: 756-3506/050-050</b> Power cable; M12L socket; angled; M12L plug; angled; 5-pole; Length: 5 m	 <b>Item No.: 756-3516/050-050</b> Power cable; M12L socket; angled; M12L plug; angled; 5-pole; Length: 5 m	 <b>Item No.: 756-3506/050-075</b> Power cable; M12L socket; angled; M12L plug; angled; 5-pole; Length: 7.5 m
 <b>Item No.: 756-3516/050-075</b> Power cable; M12L socket; angled; M12L plug; angled; 5-pole; Length: 7.5 m	 <b>Item No.: 756-3501/050-100</b> Power cable; M12L socket; straight; 5-pole; Length: 10 m	 <b>Item No.: 756-3511/050-100</b> Power cable; M12L socket; straight; 5-pole; Length: 10 m	 <b>Item No.: 756-3501/050-150</b> Power cable; M12L socket; straight; 5-pole; Length: 15 m
 <b>Item No.: 756-3511/050-150</b> Power cable; M12L socket; straight; 5-pole; Length: 15 m	 <b>Item No.: 756-3501/050-020</b> Power cable; M12L socket; straight; 5-pole; Length: 2 m	 <b>Item No.: 756-3511/050-020</b> Power cable; M12L socket; straight; 5-pole; Length: 2 m	 <b>Item No.: 756-3501/050-050</b> Power cable; M12L socket; straight; 5-pole; Length: 5 m
 <b>Item No.: 756-3511/050-050</b> Power cable; M12L socket; straight; 5-pole; Length: 5 m	 <b>Item No.: 756-3501/050-075</b> Power cable; M12L socket; straight; 5-pole; Length: 7.5 m	 <b>Item No.: 756-3511/050-075</b> Power cable; M12L socket; straight; 5-pole; Length: 7.5 m	 <b>Item No.: 756-3505/050-003</b> Power cable; M12L socket; straight; M12L plug; straight; 5-pole; Length: 0.3 m
 <b>Item No.: 756-3505/050-005</b> Power cable; M12L socket; straight; M12L plug; straight; 5-pole; Length: 0.5 m	 <b>Item No.: 756-3515/050-005</b> Power cable; M12L socket; straight; M12L plug; straight; 5-pole; Length: 0.5 m	 <b>Item No.: 756-3505/050-010</b> Power cable; M12L socket; straight; M12L plug; straight; 5-pole; Length: 1 m	 <b>Item No.: 756-3515/050-010</b> Power cable; M12L socket; straight; M12L plug; straight; 5-pole; Length: 1 m
 <b>Item No.: 756-3505/050-100</b> Power cable; M12L socket; straight; M12L plug; straight; 5-pole; Length: 10 m	 <b>Item No.: 756-3515/050-100</b> Power cable; M12L socket; straight; M12L plug; straight; 5-pole; Length: 10 m	 <b>Item No.: 756-3505/050-150</b> Power cable; M12L socket; straight; M12L plug; straight; 5-pole; Length: 15 m	 <b>Item No.: 756-3505/050-020</b> Power cable; M12L socket; straight; M12L plug; straight; 5-pole; Length: 2 m

1.2.1.6 Power cable



**Item No.: 756-3515/050-020**  
Power cable; M12L socket; straight; M12L plug; straight; 5-pole; Length: 2 m

**Item No.: 756-3515/050-200**  
Power cable; M12L socket; straight; M12L plug; straight; 5-pole; Length: 20 m

**Item No.: 756-3515/050-300**  
Power cable; M12L socket; straight; M12L plug; straight; 5-pole; Length: 30 m

**Item No.: 756-3515/050-400**  
Power cable; M12L socket; straight; M12L plug; straight; 5-pole; Length: 40 m



**Item No.: 756-3505/050-050**  
Power cable; M12L socket; straight; M12L plug; straight; 5-pole; Length: 5 m

**Item No.: 756-3515/050-050**  
Power cable; M12L socket; straight; M12L plug; straight; 5-pole; Length: 5 m

**Item No.: 756-3505/050-075**  
Power cable; M12L socket; straight; M12L plug; straight; 5-pole; Length: 7.5 m

**Item No.: 756-3515/050-075**  
Power cable; M12L socket; straight; M12L plug; straight; 5-pole; Length: 7.5 m

1.2.1.7 Sensor/actuator cable



**Item No.: 756-5312/040-015**  
Sensor/Actuator cable; M12A plug; angled; 4-pole; Length: 1.5 m

**Item No.: 756-5312/040-100**  
Sensor/Actuator cable; M12A plug; angled; 4-pole; Length: 10 m

**Item No.: 756-5312/040-050**  
Sensor/Actuator cable; M12A plug; angled; 4-pole; Length: 5 m

**Item No.: 756-5311/040-015**  
Sensor/Actuator cable; M12A plug; straight; 4-pole; Length: 1.5 m



**Item No.: 756-5311/040-100**  
Sensor/Actuator cable; M12A plug; straight; 4-pole; Length: 10 m

**Item No.: 756-5311/040-050**  
Sensor/Actuator cable; M12A plug; straight; 4-pole; Length: 5 m

**Item No.: 756-5404/040-010**  
Sensor/Actuator cable; M12A socket; angled; M12A plug; angled; 4-pole; Length: 1 m

**Item No.: 756-5404/040-020**  
Sensor/Actuator cable; M12A socket; angled; M12A plug; angled; 4-pole; Length: 2 m



**Item No.: 756-5403/040-010**  
Sensor/Actuator cable; M12A socket; angled; M12A plug; straight; 4-pole; Length: 1 m

**Item No.: 756-5403/040-020**  
Sensor/Actuator cable; M12A socket; angled; M12A plug; straight; 4-pole; Length: 2 m

**Item No.: 756-5402/040-010**  
Sensor/Actuator cable; M12A socket; straight; M12A plug; angled; 4-pole; Length: 1 m

**Item No.: 756-5402/040-020**  
Sensor/Actuator cable; M12A socket; straight; M12A plug; angled; 4-pole; Length: 2 m



**Item No.: 756-5401/040-010**  
Sensor/Actuator cable; M12A socket; straight; M12A plug; straight; 4-pole; Length: 1 m

**Item No.: 756-5401/040-020**  
Sensor/Actuator cable; M12A socket; straight; M12A plug; straight; 4-pole; Length: 2 m

**Item No.: 756-5510/040-010**  
Sensor/Actuator cable; M8 socket; angled; M12A plug; angled; 4-pole; Length: 1 m

**Item No.: 756-5510/040-020**  
Sensor/Actuator cable; M8 socket; angled; M12A plug; angled; 4-pole; Length: 2 m



**Item No.: 756-5509/040-010**  
Sensor/Actuator cable; M8 socket; angled; M12A plug; straight; 4-pole; Length: 1 m

**Item No.: 756-5509/040-020**  
Sensor/Actuator cable; M8 socket; angled; M12A plug; straight; 4-pole; Length: 2 m

**Item No.: 756-5508/040-010**  
Sensor/Actuator cable; M8 socket; straight; M12A plug; angled; 4-pole; Length: 1 m

**Item No.: 756-5508/040-020**  
Sensor/Actuator cable; M8 socket; straight; M12A plug; angled; 4-pole; Length: 2 m



**Item No.: 756-5507/040-010**  
Sensor/Actuator cable; M8 socket; straight; M12A plug; straight; 4-pole; Length: 1 m

**Item No.: 756-5507/040-020**  
Sensor/Actuator cable; M8 socket; straight; M12A plug; straight; 4-pole; Length: 2 m

1.2.2 Software

1.2.2.1 Programming and configuration software



**Item No.: 2759-106/1121-1000**  
IO-Link Configurator; Single License; Online activation

Subject to changes. Please also observe the further product documentation!

Current addresses can be found at: [www.wago.com](http://www.wago.com)