

## Data Sheet | Item Number: 790-352/790-398

Busbar carrier; for busbars Cu 10 mm x 3 mm; flexible; for DIN 35 rail; silver-colored

<https://www.wago.com/790-352/790-398>



Color: ■ silver-colored

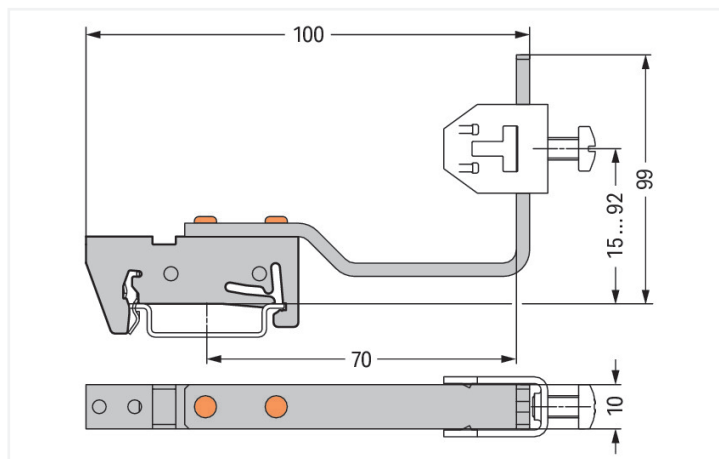

Dimensions in mm

### Material data

Color	silver-colored
Fire load	0 MJ
Weight	66.8 g
Material	Coated steel Stainless steel Copper (Cu)

### Commercial data

eCl@ss 10.0	27-40-06-07
eCl@ss 9.0	27-40-06-07
ETIM 8.0	EC001166
ETIM 7.0	EC001166
PU (SPU)	12 (6) pcs
Packaging type	Box
Country of origin	DE
GTIN	4055143363051
Customs tariff number	39269097900

### Environmental Product Compliance

RoHS Compliance Status	Compliant, No Exemption
------------------------	-------------------------

Processing temperature (min.)	-35 °C
Processing temperature (max.)	85 °C
Processing temperature	-35 ... +85 °C
Continuous operating temperature from	-60 °C
Continuous operating temperature up to	105 °C
Continuous operating temperature	-60 ... +105 °C

## Downloads

### Environmental Product Compliance

#### Compliance Search

Environmental Product Compliance  
790-352/790-398



## Documentation

### Bid Text

790-352/790-398	19.02.2019	xml 2.69 KB	
790-352/790-398	31.08.2017	doc 23.50 KB	

## CAD/CAE-Data

### CAD data

2D/3D Models  
790-352/790-398



### CAE data

EPLAN Data Portal  
790-352/790-398



ZUKEN Portal  
790-352/790-398



## 1 Compatible Products

### 1.1 Optional Accessories

#### 1.1.1 N-busbar

##### 1.1.1.1 Mounting accessories



#### Item No.: 210-133

Busbar; tin-plated; 1000 mm long; Cu 10 mm x 3 mm; white

#### Item No.: 790-134

Busbar; tin-plated; 50 mm long; Cu 10 mm x 3 mm; silver-colored

## Installation Notes

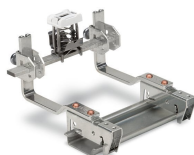

Horizontal mounting position of the busbar

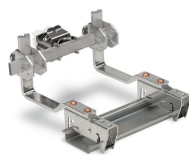

Vertical mounting position of the busbar

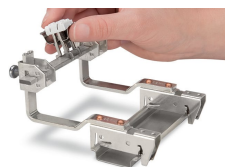

The height of the busbar can be adjusted.

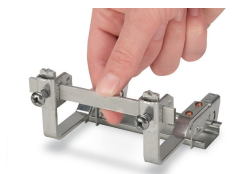

Secure the busbar by tightening the screws at the required position.