

# Data Sheet | Item Number: 2010-1204

2-conductor through terminal block; 10 mm<sup>2</sup>; for Ex e II and Ex i applications; side and center marking; for DIN-rail 35 x 15 and 35 x 7.5; Push-in CAGE CLAMP®; 10,00 mm<sup>2</sup>; blue

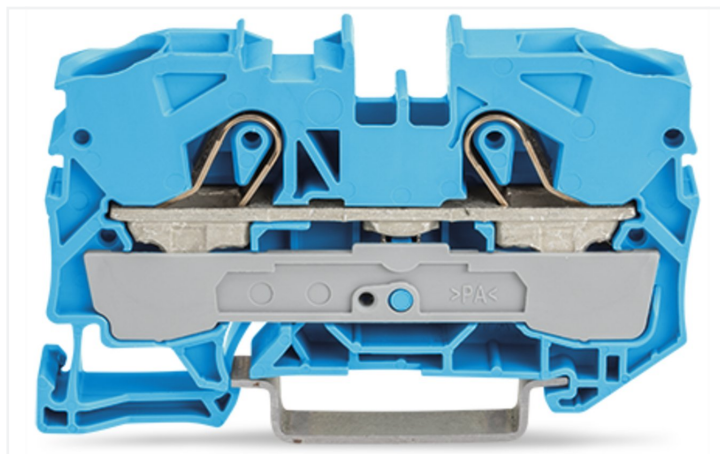

<https://www.wago.com/2010-1204>

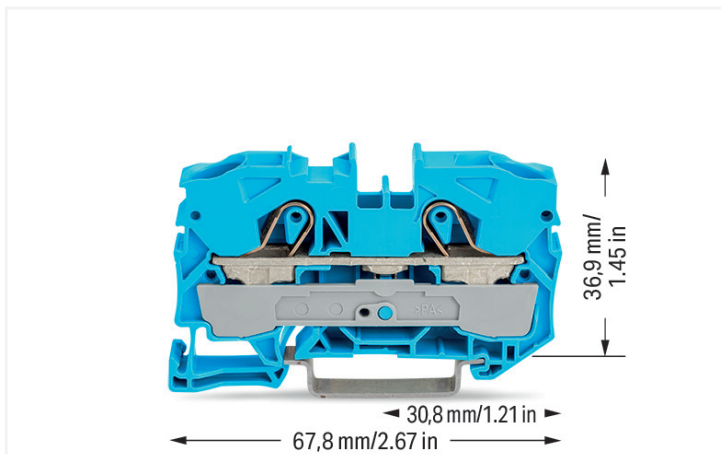

Color: ■ blue

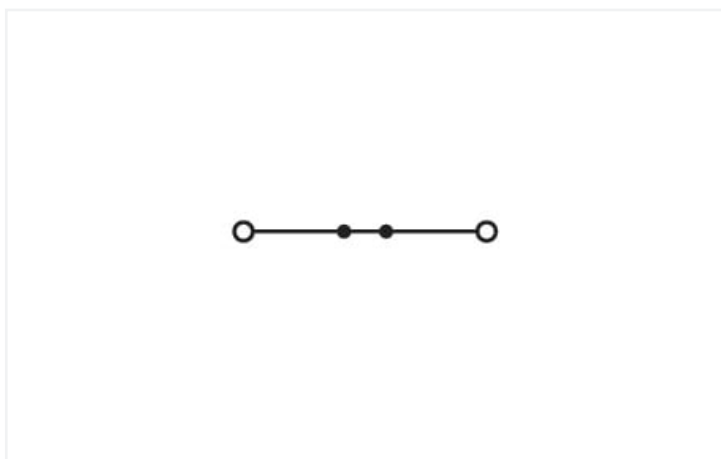

Similar to illustration

## Electrical data

Ratings per	IEC/EN 60947-7-1		
Overvoltage category	III	III	II
Pollution degree	3	2	2
Nominal voltage	800 V	-	-
Rated surge voltage	8 kV	-	-
Rated current	57 A	-	-
Current at conductor cross-section (max.) mm <sup>2</sup>	76 A	-	-

Approvals per	UL 1059		
Use group	B	C	D
Rated voltage	600 V	600 V	-
Rated current	65 A	65 A	-

Approvals per	CSA 22.2 No 158		
Use group	B	C	D
Rated voltage	600 V	600 V	-
Rated current	65 A	65 A	-

Ex information	
Reference hazardous areas	See application instructions in section "Knowledge and Downloads – Documentation – Additional Information: Technical Section; Technical Explanations"
Ratings per	ATEX: PTB 05 ATEX 1070 U / IECEx: PTB 06.0003U (Ex eb IIC Gb)
Rated voltage EN (Ex e II)	550 V
Rated current (Ex e II)	51 A

### Power Loss

Power loss, per pole (potential)	1.8194 W
Rated current $I_N$ for specified power loss	57 A
Resistance value for specified, current-dependent power loss	0.00056 $\Omega$

### Connection data

Clamping units	2
Total number of potentials	1
Number of levels	1
Number of jumper slots	2

### Connection 1

Connection technology	Push-in CAGE CLAMP®
Actuation type	Operating tool
Connectable conductor materials	Copper
Nominal cross-section	10 mm <sup>2</sup>
Solid conductor	0.5 ... 16 mm <sup>2</sup> / 20 ... 6 AWG
Solid conductor; push-in termination	4 ... 16 mm <sup>2</sup> / 14 ... 6 AWG
Fine-stranded conductor	0.5 ... 16 mm <sup>2</sup> / 20 ... 6 AWG
Fine-stranded conductor; with insulated ferrule	0.5 ... 10 mm <sup>2</sup> / 20 ... 8 AWG
Fine-stranded conductor; with ferrule; push-in termination	4 ... 10 mm <sup>2</sup> / 12 ... 8 AWG
Note (conductor cross-section)	Depending on the conductor characteristic, a conductor with a smaller cross-section can also be inserted via push-in termination. AWG specifications were converted according to IEC.
Strip length	17 ... 19 mm / 0.67 ... 0.75 inches
Wiring direction	Front-entry wiring

### Physical data

Width	10 mm / 0.394 inches
Height	67.8 mm / 2.669 inches
Depth from upper-edge of DIN-rail	36.9 mm / 1.453 inches
Depth	43.5 mm / 1.713 inches

### Mechanical data

Mounting type	DIN-35 rail
Marking level	Center/side marking

### Material data

Note (material data)	<a href="#">Information on material specifications can be found here</a>
Color	blue
Material group	I
Insulation material (main housing)	Polyamide (PA66)
Flammability class per UL94	V0
Fire load	0.32 MJ
Weight	17.3 g

## Environmental requirements

Processing temperature	-35 ... +85 °C
Continuous operating temperature	-60 ... +105 °C

## Environmental Testing (Environmental Conditions)

Test specification Railway applications – Rolling stock – Electronic equipment	DIN EN 50155 (VDE 0115-200):2022-06
Test procedure Railway applications – Rolling stock equipment – Shock and vibration tests	DIN EN 61373 (VDE 0115-0106):2011-04
Spectrum/Installation location	Service life test, Category 1, Class A/B
Function test with noise-like vibration	Test passed according to Section 8 of the standard
Frequency	$f_1 = 5 \text{ Hz}$ to $f_2 = 150 \text{ Hz}$ $f_1 = 5 \text{ Hz}$ to $f_2 = 150 \text{ Hz}$
Acceleration	0.101g (highest test level used for all axes) 0.572g (highest test level used for all axes) 5g (highest test level used for all axes)
Test duration per axis	10 min. 5 h
Test directions	X, Y and Z axes X, Y and Z axes X, Y and Z axes
Monitoring for contact faults/interruptions	Passed
Voltage drop measurement before and after each axis	Passed
Simulated service life test through increased levels of noise-like vibration	Test passed according to Section 9 of the standard
Extended test scope: Monitoring for contact faults/interruptions	Passed Passed
Extended test scope: Voltage drop measurement before and after each axis	Passed Passed
Shock test	Test passed according to Section 10 of the standard
Shock form	Half sine
Shock duration	30 ms
Number of shocks per axis	3 pos. und 3 neg.
Vibration and shock stress for rolling stock equipment	Passed

## Commercial data

Product Group	22 (TOPJOB S)
eCl@ss 10.0	27-14-11-20
eCl@ss 9.0	27-14-11-20
ETIM 9.0	EC000897
ETIM 8.0	EC000897
PU (SPU)	25 pcs
Packaging type	Box
Country of origin	DE
GTIN	4017332076166
Customs tariff number	85369010000

## Environmental Product Compliance

RoHS Compliance Status

Compliant, No Exemption

## Approvals / Certificates

### General approvals



Approval	Standard	Certificate Name
CCA DEKRA Certification B.V.	EN 60947	NTR NL 7876
CSA DEKRA Certification B.V.	C22.2 No. 158	70111238
KEMA/KEUR DEKRA Certification B.V.	EN 60947	71-119201
UL UL International Germany GmbH	UL 1059	E45172

### Declarations of conformity and manufacturer's declarations



Approval	Standard	Certificate Name
ATEX-Attestation of Conformity WAGO GmbH & Co. KG	-	-
EU-Declaration of Conformity WAGO GmbH & Co. KG	-	-
Railway WAGO GmbH & Co. KG	-	Railway Ready
UK-Declaration of Conformity WAGO GmbH & Co. KG	-	-

### Approvals for marine applications



Approval	Standard	Certificate Name
ABS American Bureau of Shipping	-	20-HG1941090-PDA
DNV GL Det Norske Veritas, Germanischer Lloyd	-	TAE00001V2

### Approvals for hazardous areas



Approval	Standard	Certificate Name
AEx UL International Germany GmbH c/o Physikalisch Technische Bundesanstalt	UL 60079	E185892 (Ex e II)
ATEX Physikalisch Technische Bundesanstalt (PTB)	EN 60079	PTB 05 ATEX 1070 U (II 2 G Ex eb II C bzw. I M 2 Ex eb I Mb)
CCC CNEX	GB/T 3836.3	2020312313000161 (Ex eb IIC Gb, Ex eb I Mb)
EAC Brjansker Zertifizierungsstelle	TP TC 012/2011	RU C-DE.AM02.B.00127/19 (Ex e IIC Gb U)
IECEX Physikalisch Technische Bundesanstalt (PTB)	IEC 60079	IECEX PTB 06.0003 U (Ex eb IIC Gb and Ex ebl Mb)
INMETRO TÜV Rheinland do Brasil Ltda.	IEC 60079	TÜV 12.1311 U

## Downloads

### Environmental Product Compliance

#### Compliance Search

 Environmental Product Compliance 2010-1204
 

Documentation

Additional Information

Technical Section	pdf 2246.92 KB	
-------------------	-------------------	--

Bid Text

2010-1204	17.04.2019	xml 3.96 KB	
2010-1204	17.04.2019	docx 14.83 KB	

CAD/CAE-Data

CAD data

2D/3D Models 2010-1204	
---------------------------	--

CAE data

EPLAN Data Portal 2010-1204	
WSCAD Universe 2010-1204	
ZUKEN Portal 2010-1204	

1 Compatible Products

1.1 Required Accessories

1.1.1 End plate

1.1.1.1 End plate



**Item No.: 2010-1291**  
End and intermediate plate; 1 mm thick; gray



**Item No.: 2010-1292**  
End and intermediate plate; 1 mm thick; orange



**Item No.: 209-191**  
Separator for Ex e/Ex i applications; 3 mm thick; 120 mm wide; orange

1.2 Optional Accessories

1.2.1 Cover

1.2.1.1 Cover



**Item No.: 2010-100**  
Finger guard; touchproof cover protects unused conductor entries; yellow

1.2.2 DIN-rail

1.2.2.1 Mounting accessories



**Item No.: 210-196**  
Aluminum carrier rail; 35 x 8.2 mm; 1.6 mm thick; 2 m long; unslotted; similar to EN 60715; silver-colored



**Item No.: 210-198**  
Copper carrier rail; 35 x 15 mm; 2.3 mm thick; 2 m long; unslotted; according to EN 60715; copper-colored



**Item No.: 210-197**  
Steel carrier rail; 35 x 15 mm; 1.5 mm thick; 2 m long; slotted; similar to EN 60715; silver-colored



**Item No.: 210-114**  
Steel carrier rail; 35 x 15 mm; 1.5 mm thick; 2 m long; unslotted; similar to EN 60715; silver-colored

1.2.2.1 Mounting accessories



**Item No.: 210-118**

Steel carrier rail; 35 x 15 mm; 2.3 mm thick; 2 m long; unslotted; according to EN 60715; silver-colored

**Item No.: 210-113**

Steel carrier rail; 35 x 7.5 mm; 1 mm thick; 2 m long; unslotted; according to EN 60715; silver-colored

1.2.3 Ferrule

1.2.3.1 Ferrule



**Item No.: 216-284**

Ferrule; Sleeve for 1.5 mm<sup>2</sup> / AWG 16; insulated; electro-tin plated; electrolytic copper; gastight crimped; acc. to DIN 46228, Part 4/09.90; black



**Item No.: 216-289**

Ferrule; Sleeve for 10 mm<sup>2</sup> / AWG 8; insulated; electro-tin plated; electrolytic copper; gastight crimped; acc. to DIN 46228, Part 4/09.90; red



**Item No.: 216-286**

Ferrule; Sleeve for 2.5 mm<sup>2</sup> / AWG 14; insulated; electro-tin plated; electrolytic copper; gastight crimped; acc. to DIN 46228, Part 4/09.90; blue



**Item No.: 216-287**

Ferrule; Sleeve for 4 mm<sup>2</sup> / AWG 12; insulated; electro-tin plated; electrolytic copper; gastight crimped; acc. to DIN 46228, Part 4/09.90; gray



**Item No.: 216-288**

Ferrule; Sleeve for 6 mm<sup>2</sup> / AWG 10; insulated; electro-tin plated; electrolytic copper; gastight crimped; acc. to DIN 46228, Part 4/09.90; yellow

1.2.4 Installation

1.2.4.1 Cover



**Item No.: 709-156**

Cover; Type 3; suitable for cover carrier, type 3; 1 m long; transparent

1.2.4.2 Cover carrier



**Item No.: 709-169**

Cover carrier; Type 3; incl. fixing/retaining screws and knurled nut; suitable for 279 to 282 and 880 Series rail-mounted terminal blocks; suitable for 264 Series miniature rail-mounted terminal blocks; suitable for 270 Series sensor and actuator terminal blocks; gray

1.2.5 Jumper

1.2.5.1 Jumper



**Item No.: 2010-402**

Jumper; 2-way; insulated; light gray



**Item No.: 2010-403**

Jumper; 3-way; insulated; light gray



**Item No.: 2010-404**

Jumper; 4-way; insulated; light gray



**Item No.: 2010-405**

Jumper; 5-way; insulated; light gray



**Item No.: 2010-433**

Jumper; from 1 to 3; insulated; light gray



**Item No.: 2010-434**

Jumper; from 1 to 4; insulated; light gray



**Item No.: 2010-435**

Jumper; from 1 to 5; insulated; light gray



**Item No.: 2010-405/011-000**

Star point jumper; 3-way; insulated; light gray

1.2.5.1 Jumper



**Item No.: 2016-499**  
 Step-down jumper; from 2016/2010 to 2010/2006/2004/2002 series; from 2216/2210 to 2210/2206/2204/2202 series; insulated; light gray

**Item No.: 285-430**  
 Step-down jumper; from 285 (35mm<sup>2</sup>) to 2016/2010 series; insulated; gray

1.2.6 Marking

1.2.6.1 Group marker carrier



**Item No.: 2009-191**  
 Group marker carrier; gray

**Item No.: 2009-192**  
 Group marker carrier; gray

**Item No.: 2009-193**  
 Group marker carrier; gray

1.2.6.2 Marker

<p><b>Item No.: 2009-145/000-006</b>                  Mini-WSB Inline; for Smart Printer; 1700 pieces on roll; stretchable 5 - 5.2 mm; plain; snap-on type; blue</p>	<p><b>Item No.: 2009-145/000-007</b>                  Mini-WSB Inline; for Smart Printer; 1700 pieces on roll; stretchable 5 - 5.2 mm; plain; snap-on type; gray</p>	<p><b>Item No.: 2009-145/000-023</b>                  Mini-WSB Inline; for Smart Printer; 1700 pieces on roll; stretchable 5 - 5.2 mm; plain; snap-on type; green</p>	<p><b>Item No.: 2009-145/000-012</b>                  Mini-WSB Inline; for Smart Printer; 1700 pieces on roll; stretchable 5 - 5.2 mm; plain; snap-on type; orange</p>
<p><b>Item No.: 2009-145/000-005</b>                  Mini-WSB Inline; for Smart Printer; 1700 pieces on roll; stretchable 5 - 5.2 mm; plain; snap-on type; red</p>	<p><b>Item No.: 2009-145/000-024</b>                  Mini-WSB Inline; for Smart Printer; 1700 pieces on roll; stretchable 5 - 5.2 mm; plain; snap-on type; violet</p>	<p><b>Item No.: 2009-145</b>                  Mini-WSB Inline; for Smart Printer; 1700 pieces on roll; stretchable 5 - 5.2 mm; plain; snap-on type; white</p>	<p><b>Item No.: 2009-145/000-002</b>                  Mini-WSB Inline; for Smart Printer; 1700 pieces on roll; stretchable 5 - 5.2 mm; plain; snap-on type; yellow</p>
<p><b>Item No.: 248-501/000-006</b>                  Mini-WSB marking card; as card; not stretchable; plain; snap-on type; blue</p>	<p><b>Item No.: 248-501/000-007</b>                  Mini-WSB marking card; as card; not stretchable; plain; snap-on type; gray</p>	<p><b>Item No.: 248-501/000-023</b>                  Mini-WSB marking card; as card; not stretchable; plain; snap-on type; green</p>	<p><b>Item No.: 248-501/000-017</b>                  Mini-WSB marking card; as card; not stretchable; plain; snap-on type; light green</p>
<p><b>Item No.: 248-501/000-012</b>                  Mini-WSB marking card; as card; not stretchable; plain; snap-on type; orange</p>	<p><b>Item No.: 248-501/000-005</b>                  Mini-WSB marking card; as card; not stretchable; plain; snap-on type; red</p>	<p><b>Item No.: 248-501/000-024</b>                  Mini-WSB marking card; as card; not stretchable; plain; snap-on type; violet</p>	<p><b>Item No.: 248-501</b>                  Mini-WSB marking card; as card; not stretchable; plain; snap-on type; white</p>
<p><b>Item No.: 248-501/000-002</b>                  Mini-WSB marking card; as card; not stretchable; plain; snap-on type; yellow</p>	<p><b>Item No.: 793-5501/000-006</b>                  WMB marking card; as card; for terminal block width 5 - 17.5 mm; stretchable 5 - 5.2 mm; plain; snap-on type; blue</p>	<p><b>Item No.: 793-5501/000-007</b>                  WMB marking card; as card; for terminal block width 5 - 17.5 mm; stretchable 5 - 5.2 mm; plain; snap-on type; gray</p>	<p><b>Item No.: 793-5501/000-023</b>                  WMB marking card; as card; for terminal block width 5 - 17.5 mm; stretchable 5 - 5.2 mm; plain; snap-on type; green</p>
<p><b>Item No.: 793-5501/000-017</b>                  WMB marking card; as card; for terminal block width 5 - 17.5 mm; stretchable 5 - 5.2 mm; plain; snap-on type; light green</p>	<p><b>Item No.: 793-5501/000-012</b>                  WMB marking card; as card; for terminal block width 5 - 17.5 mm; stretchable 5 - 5.2 mm; plain; snap-on type; orange</p>	<p><b>Item No.: 793-5501/000-005</b>                  WMB marking card; as card; for terminal block width 5 - 17.5 mm; stretchable 5 - 5.2 mm; plain; snap-on type; red</p>	<p><b>Item No.: 793-5501/000-024</b>                  WMB marking card; as card; for terminal block width 5 - 17.5 mm; stretchable 5 - 5.2 mm; plain; snap-on type; violet</p>
<p><b>Item No.: 793-5501</b>                  WMB marking card; as card; for terminal block width 5 - 17.5 mm; stretchable 5 - 5.2 mm; plain; snap-on type; white</p>	<p><b>Item No.: 793-5501/000-002</b>                  WMB marking card; as card; for terminal block width 5 - 17.5 mm; stretchable 5 - 5.2 mm; plain; snap-on type; yellow</p>	<p><b>Item No.: 793-501/000-006</b>                  WMB marking card; as card; not stretchable; plain; snap-on type; blue</p>	<p><b>Item No.: 793-501/000-007</b>                  WMB marking card; as card; not stretchable; plain; snap-on type; gray</p>
<p><b>Item No.: 793-501/000-023</b>                  WMB marking card; as card; not stretchable; plain; snap-on type; green</p>	<p><b>Item No.: 793-501/000-017</b>                  WMB marking card; as card; not stretchable; plain; snap-on type; light green</p>	<p><b>Item No.: 793-501/000-012</b>                  WMB marking card; as card; not stretchable; plain; snap-on type; orange</p>	<p><b>Item No.: 793-501/000-005</b>                  WMB marking card; as card; not stretchable; plain; snap-on type; red</p>

**1.2.6.2 Marker**



**Item No.: 793-501/000-024**  
WMB marking card; as card; not stretchable; plain; snap-on type; violet

**Item No.: 793-501**  
WMB marking card; as card; not stretchable; plain; snap-on type; white

**Item No.: 793-501/000-002**  
WMB marking card; as card; not stretchable; plain; snap-on type; yellow

**Item No.: 2009-115/000-006**  
WMB-Inline; for Smart Printer; 1500 pieces on roll; stretchable 5 - 5.2 mm; plain; snap-on type; blue



**Item No.: 2009-115/000-007**  
WMB-Inline; for Smart Printer; 1500 pieces on roll; stretchable 5 - 5.2 mm; plain; snap-on type; gray

**Item No.: 2009-115/000-023**  
WMB-Inline; for Smart Printer; 1500 pieces on roll; stretchable 5 - 5.2 mm; plain; snap-on type; green

**Item No.: 2009-115/000-017**  
WMB-Inline; for Smart Printer; 1500 pieces on roll; stretchable 5 - 5.2 mm; plain; snap-on type; light green

**Item No.: 2009-115/000-012**  
WMB-Inline; for Smart Printer; 1500 pieces on roll; stretchable 5 - 5.2 mm; plain; snap-on type; orange



**Item No.: 2009-115/000-024**  
WMB-Inline; for Smart Printer; 1500 pieces on roll; stretchable 5 - 5.2 mm; plain; snap-on type; violet

**Item No.: 2009-115**  
WMB-Inline; for Smart Printer; 1500 pieces on roll; stretchable 5 - 5.2 mm; plain; snap-on type; white

**Item No.: 2009-115/000-002**  
WMB-Inline; for Smart Printer; 1500 pieces on roll; stretchable 5 - 5.2 mm; plain; snap-on type; yellow

**1.2.6.3 Marker carrier**



**Item No.: 2009-198**  
Adaptor; gray

**1.2.6.4 Marking strip**



**Item No.: 2009-110**  
Marking strips; for Smart Printer; on reel; not stretchable; plain; snap-on type; white

**1.2.7 Protective warning marker**

**1.2.7.1 Cover**



**Item No.: 2010-115**  
Protective warning marker; for 5 terminal blocks; with high-voltage symbol, black; yellow

**1.2.8 Screwless end stop**

**1.2.8.1 Mounting accessories**



**Item No.: 249-117**  
Screwless end stop; 10 mm wide; for DIN-rail 35 x 15 and 35 x 7.5; gray

**Item No.: 249-116**  
Screwless end stop; 6 mm wide; for DIN-rail 35 x 15 and 35 x 7.5; gray



## 1.2.9 Test and measurement

### 1.2.9.1 Testing accessories



**Item No.: 2010-511**

Modular TOPJOB®S connector; modular; for jumper contact slot; 1-pole; 4,00 mm<sup>2</sup>; gray



**Item No.: 2010-549**

Spacer module; modular; e.g., for bridging commoned terminal blocks; gray



**Item No.: 2009-174**

Test plug adapter; for 4 mm Ø test plugs; for testing TOPJOB®S rail-mounted terminal blocks; gray



**Item No.: 2009-182**

Testing tap; for max. 2.5 mm<sup>2</sup>; tool-free connection for individual test wires 0.08 - 2.5 mm; gray

## 1.2.10 Tool

### 1.2.10.1 Operating tool



**Item No.: 210-721**

Operating tool; Blade: 5.5 x 0.8 mm; with a partially insulated shaft; multicoloured

## Installation Notes

### Conductor termination

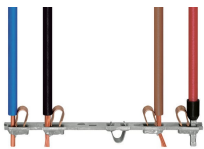

**All conductor types at a glance**

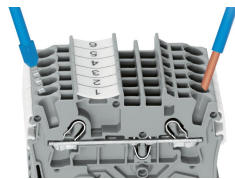

Push-in termination of solid and ferruled conductors

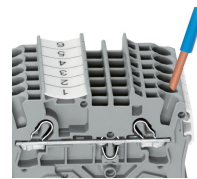

**Inserting a conductor via push-in termination:**

Solid conductors with cross-sections from either one size above, or up to two sizes below, the rated cross-section can be simply pushed in – no tools needed.

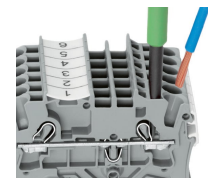

**Inserting a conductor via operating tool:**

Connecting fine-stranded conductors without ferrules, or small cross-sectional conductors that cannot be pushed in, is performed similarly to the original CAGE CLAMP® – just use an operating tool.

**Advantage:**

To open the clamp, the operating tool is inserted vertically. The conductor entry is less than 15 degrees for easier wiring.

### Commoning

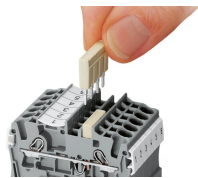

Insert push-in type jumper bar and push down until it hits backstop.

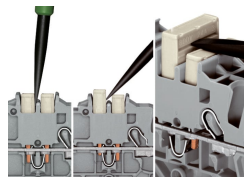

**Removing a push-in type jumper bar:**

Insert the operating tool between the jumper and partition wall of the dual jumper slots, then lift up the jumper. Place the operating tool in the center of jumpers for up to five contacts (see above), or alternately on both sides for jumpers with more than five contacts.

Commoning

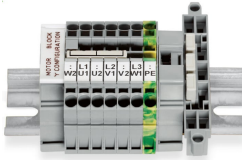

This star point jumper has been specially developed to create a "star point" and is used on motor terminal boards equipped with Rail-Mount Terminal Blocks TOPJOB® S.

Commoning

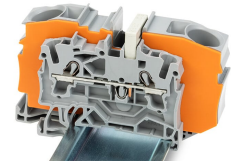
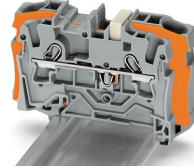
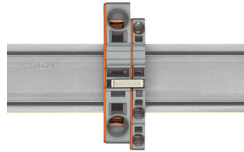
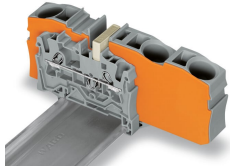

Step-down jumpers common terminal blocks of different sizes, without losing a conductor clamping point. This can be beneficial on long conductor runs where voltage drop can be a problem. A large conductor can be easily connected to smaller conductors at the distribution point. Commoning may be made in either direction using the special thin end plate to cover the open side. Additional through terminal blocks having a smaller cross-section may be commoned using push-in type jumper bars.

**Using step-down jumpers**, an end plate must be inserted between the terminal blocks to be commoned.

**Step-down jumper (Item No. 2006-499)** commons 6/4 mm<sup>2</sup> (10/12 AWG) terminal blocks (2006/2004 Series) with 4/2.5/1.5 mm<sup>2</sup> (AWG 12/14/16) terminal blocks (2004/2002/2001 Series).

**Step-down jumper (Item No. 2016-499)** commons 16/10 mm<sup>2</sup> (16/8 AWG) terminal blocks (2016/2010 Series) with 10/6/4/2.5 mm<sup>2</sup> (8/10/12/14 AWG) terminal blocks (2010/2006/2004/2002 Series).

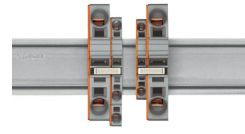
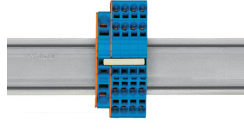
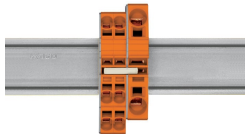

**Stepping down via push-in type jumper bar:** Commoning via open terminal side with end plate allows jumpering over two cross-section sizes for 16 mm<sup>2</sup> (6 AWG) and 10 mm<sup>2</sup> (8 AWG) and one cross-section size for 6/4/2.5 mm<sup>2</sup> (10/12/14 AWG). An example: from 16 mm<sup>2</sup> (6 AWG) to 6 mm<sup>2</sup> (10 AWG) (see illustration above) or from 10 mm<sup>2</sup> (8 AWG) to 4 mm<sup>2</sup> (12 AWG).

**Stepping down via push-in type jumper bar:** Commoning via closed terminal side with end plate allows jumpering over two cross-section sizes, e.g., from 16 mm<sup>2</sup> (6 AWG) to 6 mm<sup>2</sup> (10 AWG) or from 6 mm<sup>2</sup> (10 AWG) to 2.5 mm<sup>2</sup> (14 AWG) (see illustration above).

**Note:** The total current of the outgoing circuits must not exceed the nominal current of the step-down jumper/push-in type jumper bar.

Testing

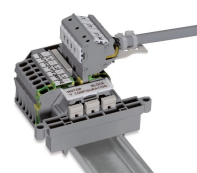
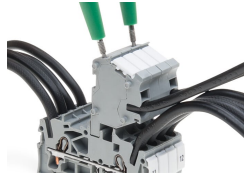

The modular TOPJOB® S connectors also connect conductors of the same size as the terminal blocks being used.

TOPJOB® S Connectors with a 2 mm Ø test socket for testing voltage via 2-pole voltage tester

Rail-mount terminal block assembly for electric motor wiring

Test plug adapter (Item No. 2009-174, CAT II) for 4 mm Ø plugs – compatible with 2000 to 2016 Series

Testing



Testing tap (Item No. 2009-182) for tool-free connection of test cables up to 2.5 mm<sup>2</sup> (12 AWG) – compatible with 2000 to 2016 Series

Marking

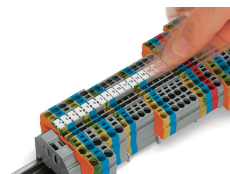

Snapping WMB Inline markers into marker slots.

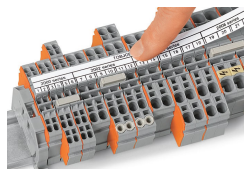

TOPJOB® S 2009-193 Group Marker Carrier (equipped with a marking strip) for all 2001 to 2016 Series TOPJOB® S Rail-Mount Terminal Blocks  
Do not use on an end plate!



Ex application

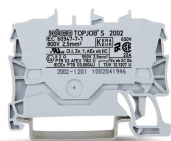

Through terminal blocks with a blue insulated housing are suitable for Ex i applications.

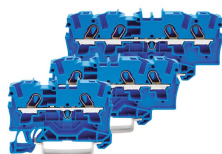

All through and ground conductor terminal blocks are suitable for Ex e II applications.

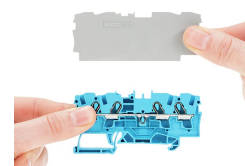

**Separator plate for Ex e/Ex i applications**

An end plate must be applied to the terminal block located directly behind an Ex e/Ex i separator plate.

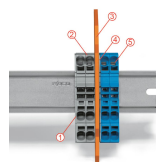
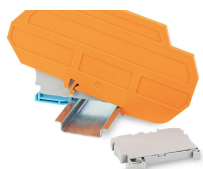

**Ex e II/Ex i terminal strip**

**Note:**  
The movable feet of terminal blocks and separator plates must face the same direction.

A separator plate is located between the Ex e II and Ex i terminal strip.  
End plate  
Ex e II terminal blocks  
Separator plate for Ex e/Ex i applications  
End plate  
Ex i terminal blocks  
According to EN 50020, a minimum distance of 50 mm must be kept between live parts of Ex e and Ex i circuits. The use of Ex e/Ex i separators is a space-saving solution when Ex e and Ex i terminal blocks are mounted on a common DIN-rail.