

Data Sheet | Item Number: 765-1202/100-000

16-channel digital input/output; EtherCAT; DC 24 V / 2.0 A; 8xM12 connection; Wi-deLine

<https://www.wago.com/765-1202/100-000>

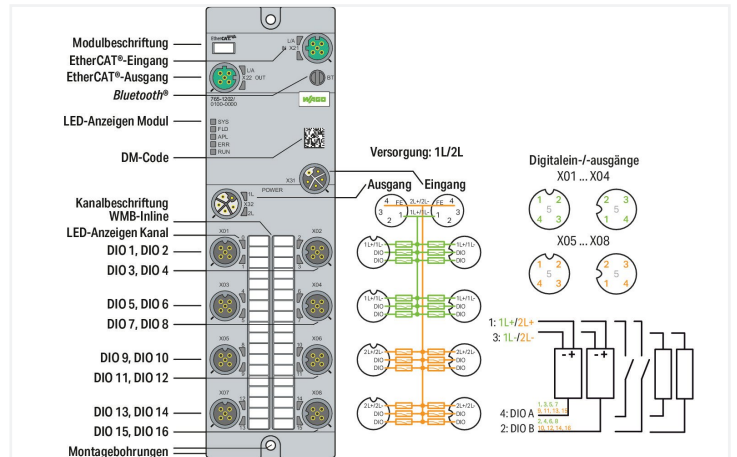

Application area:

Decentralized processing of digital signals

This device controls digital field devices (e.g., actuators) and records digital signals (e.g., sensors) that are sent or received by a higher-level controller.

The device offers 16 digital inputs/outputs.

Technical data		Device functions	
Fieldbus		Device functions	
Communications	EtherCAT® AoE, EoE, FoE	Parameter	Input filter Output current Temperature
Connection technology: communication/fieldbus	2 x D-coded M12; 4-pole	Diagnostics	Undervoltage; overcurrent; overload; overtemperature
Interface standard	10BASE-T/100BASE-TX; potential-free	Device functions	Bluetooth® OPC UA server
Autonegotiation; autocrossover	Yes	Visualization	Web server Android/iOS app

Digital inputs/outputs

Number of digital inputs	16
Number of digital outputs	16
Connection technology: inputs/outputs	8 x A-coded M12; 5-pole
Signal type (voltage)	24 VDC
Input characteristic	high-side switching Type 3, per IEC 61131-2
Input filter	0.2 ... 20 ms
Output current (per channel)	2 A (typ.) for DO
Supply current per port	1L/2L: 4 A (max.)

Supply (module)

Connection technology: supply	2 x L-coded M12; 5-pole
Supply voltage	24 VDC (18 ... 31.2 V); 1L/2L
Current consumption (max.)	16000 mA
Current consumption (note)	per supply line; overload- and short-circuit-protected
Reverse voltage protection	Yes

Physical data

Width	60 mm / 2.362 inches
Height	30 mm / 1.181 inches
Depth	210 mm / 8.268 inches

Mechanical data

Weight	610 g
Conformity marking	CE

Environmental requirements

Ambient temperature (operation)	-25 ... +70 °C
Ambient temperature (storage)	-40 ... +80 °C
Protection type	IP67
Protection class	III per EN 61140, IEC 61140, VDE 0140-1
Operating altitude	0 ... 2000 m / 0 ... 6562 ft
Pollution degree	3 (EN 60664-1)
Overvoltage category	II (EN 60664-1)
Relative humidity (without condensation)	95 %
Vibration resistance	5g per IEC 60068-2-6
Shock resistance	Short-term: 50g/11 ms/half-sine per IEC 60068-2-27; Long-term: 30g/6 ms/half-sine per IEC 60068-2-29
EMC immunity to interference	per EN 61000-6-2
EMC emission of interference	per EN 61000-6-4

Commercial data

ETIM 9.0	EC001599
ETIM 8.0	EC001599
PU (SPU)	1 pcs
Packaging type	Box
Country of origin	DE
GTIN	4066966063011
Customs tariff number	85371098990

Environmental Product Compliance

RoHS Compliance Status	Compliant, No Exemption
------------------------	-------------------------

Approvals / Certificates

General approvals **Declarations of conformity and manufacturer's declarations**



Approval	Standard	Certificate Name
EAC GZO Almaty Standart	TP TC 020/2011	EAC CoC 03083
KC National Radio Research Agency	Article 58-2, Clause 3	KC R-R-W43-FB765
UL Underwriters Laboratories Inc. (ORDINARY LOCATIONS)	-	E175199

Approval	Standard	Certificate Name
EU-Declaration of Conformity WAGO GmbH & Co. KG	-	-

Downloads

Environmental Product Compliance

Compliance Search	
Environmental Product Compliance 765-1202/100-000	↓

Documentation

Manual			
Product Manual 16-Channel Digital Input/Output; EtherCAT; 24 VDC / 2.0 A;	V 2.0.0 19.07.2022	pdf 7784.80 KB	↓

System Description	
WAGO I/O System Field; General Product Information	pdf 1009.23 KB ↓

Application Notes

Application Note e!COCKPIT			
e!COCKPIT Application Note EtherCAT IO-Field (a2022003)	1.0.0 23.03.2023	pptx 2143.63 KB	↓

CAD/CAE-Data

CAD data

2D/3D Models
765-1202/100-000



CAE data

EPLAN Data Portal
765-1202/100-000



Runtime Software

Firmware

0765-x2xx, EtherCat IO-Field	V 04 02.02.2023	zip 1582.68 KB	
------------------------------	--------------------	-------------------	--



Libraries

Device Description File

Gerätebeschreibungsdateien 765-42xx, 765-12xx, EtherCAT	V1_1_0_22	zip 75.78 KB	
---	-----------	-----------------	--



1 Compatible Products

1.1 Required Accessories

1.1.1 Cover

1.1.1.1 Cover



Item No.: 756-8103

M12 protective cap; for unused plugs

Item No.: 756-8102

M12 protective cap; for unused sockets

1.1.2 Marking

1.1.2.1 Marker



Item No.: 2009-115

WMB-Inline; for Smart Printer; 1500 pieces on roll; stretchable 5 - 5.2 mm; plain; snap-on type; white

1.1.2.2 Marking strip



Item No.: 2009-110

Marking strips; for Smart Printer; on reel; not stretchable; plain; snap-on type; white

1.1.3 Tool

1.1.3.1 Assembly tool



Item No.: 206-701

Torque wrench M8 and M12; Assembly kit

1.2 Optional Accessories

1.2.1 Cables and connectors

1.2.1.1 Adapter



Item No.: 756-9503/040-000

Accessories; 4-pole



Item No.: 756-9504/040-000

Accessories; 4-pole

1.2.1.2 Configurable Connector



Item No.: 756-9205/040-000

Fitted pluggable connector; 4-pole; M12 plug, right angle; Spring



Item No.: 756-9202/040-000

Fitted pluggable connector; 4-pole; M12 plug, straight, A-coded; Spring



Item No.: 756-9701/050-000

Fitted pluggable connector; 5-pole, shielded; M12 plug, straight; IDC technology



Item No.: 756-9711/050-000

Fitted pluggable connector; 5-pole, shielded; M12 socket, straight; IDC technology

1.2.1.3 Configurable Shielded Connector



Item No.: 756-9501/040-000

Accessories; M12 plug, right angle; 4-pole



Item No.: 756-9501/060-000

Fitted pluggable connector; 4-pole, shielded; M12 plug, straight, D-coded; Spring

1.2.1.4 Distribution connector



Item No.: 756-9301/040-000

Accessories; 4-pole



Item No.: 756-9301/050-000

Accessories; 5-pole



Item No.: 756-5517/040-010

Sensor/Actuator cable; 2xM12 socket; angled; M12A plug; straight; 4-pole; Length: 1 m



Item No.: 756-5517/040-020

Sensor/Actuator cable; 2xM12 socket; angled; M12A plug; straight; 4-pole; Length: 2 m



Item No.: 756-5516/040-010

Sensor/Actuator cable; 2xM12 socket; straight; M12A plug; straight; 4-pole; Length: 1 m



Item No.: 756-5516/040-020

Sensor/Actuator cable; 2xM12 socket; straight; M12A plug; straight; 4-pole; Length: 2 m



Item No.: 756-5514/040-010

Sensor/Actuator cable; 2xM8 socket; angled; M12A plug; straight; 4-pole; Length: 1 m



Item No.: 756-5514/040-020

Sensor/Actuator cable; 2xM8 socket; angled; M12A plug; straight; 4-pole; Length: 2 m



Item No.: 756-5513/040-010

Sensor/Actuator cable; 2xM8 socket; straight; M12A plug; straight; 4-pole; Length: 1 m































Item No.: 756-5513/040-020

Sensor/Actuator cable; 2xM8 socket; straight; M12A plug; straight; 4-pole; Length: 2 m

1.2.1.5 ETHERNET/PROFINET cable

 Item No.: 756-1202/060-100 ETHERNET cable; M12D plug; angled; 4-pole; Length: 10 m	 Item No.: 756-1202/060-020 ETHERNET cable; M12D plug; angled; 4-pole; Length: 2 m	 Item No.: 756-1202/060-200 ETHERNET cable; M12D plug; angled; 4-pole; Length: 20 m	 Item No.: 756-1202/060-050 ETHERNET cable; M12D plug; angled; 4-pole; Length: 5 m
 Item No.: 756-1204/060-010 ETHERNET cable; M12D plug; angled; M12D plug; angled; 4-pole; Length: 1 m	 Item No.: 756-1204/060-100 ETHERNET cable; M12D plug; angled; M12D plug; angled; 4-pole; Length: 10 m	 Item No.: 756-1204/060-020 ETHERNET cable; M12D plug; angled; M12D plug; angled; 4-pole; Length: 2 m	 Item No.: 756-1204/060-200 ETHERNET cable; M12D plug; angled; M12D plug; angled; 4-pole; Length: 20 m
 Item No.: 756-1204/060-030 ETHERNET cable; M12D plug; angled; M12D plug; angled; 4-pole; Length: 3 m	 Item No.: 756-1204/060-050 ETHERNET cable; M12D plug; angled; M12D plug; angled; 4-pole; Length: 5 m	 Item No.: 756-1201/060-100 ETHERNET cable; M12D plug; straight; 4-pole; Length: 10 m	 Item No.: 756-1201/060-020 ETHERNET cable; M12D plug; straight; 4-pole; Length: 2 m
 Item No.: 756-1201/060-200 ETHERNET cable; M12D plug; straight; 4-pole; Length: 20 m	 Item No.: 756-1201/060-050 ETHERNET cable; M12D plug; straight; 4-pole; Length: 5 m	 Item No.: 756-1203/060-100 ETHERNET cable; M12D plug; straight; M12D plug; straight; 4-pole; Length: 10 m	 Item No.: 756-1203/060-020 ETHERNET cable; M12D plug; straight; M12D plug; straight; 4-pole; Length: 2 m
 Item No.: 756-1203/060-200 ETHERNET cable; M12D plug; straight; M12D plug; straight; 4-pole; Length: 20 m	 Item No.: 756-1203/060-050 ETHERNET cable; M12D plug; straight; M12D plug; straight; 4-pole; Length: 5 m		

1.2.1.6 Power cable

 Item No.: 756-3504/050-100 Power cable; M12L plug; angled; 5-pole; Length: 10 m	 Item No.: 756-3514/050-100 Power cable; M12L plug; angled; 5-pole; Length: 10 m	 Item No.: 756-3504/050-150 Power cable; M12L plug; angled; 5-pole; Length: 15 m	 Item No.: 756-3514/050-150 Power cable; M12L plug; angled; 5-pole; Length: 15 m
 Item No.: 756-3504/050-020 Power cable; M12L plug; angled; 5-pole; Length: 2 m	 Item No.: 756-3504/050-050 Power cable; M12L plug; angled; 5-pole; Length: 5 m	 Item No.: 756-3514/050-050 Power cable; M12L plug; angled; 5-pole; Length: 5 m	 Item No.: 756-3504/050-075 Power cable; M12L plug; angled; 5-pole; Length: 7.5 m
 Item No.: 756-3514/050-075 Power cable; M12L plug; angled; 5-pole; Length: 7.5 m	 Item No.: 756-3503/050-100 Power cable; M12L plug; straight; 5-pole; Length: 10 m	 Item No.: 756-3513/050-100 Power cable; M12L plug; straight; 5-pole; Length: 10 m	 Item No.: 756-3503/050-150 Power cable; M12L plug; straight; 5-pole; Length: 15 m
 Item No.: 756-3513/050-150 Power cable; M12L plug; straight; 5-pole; Length: 15 m	 Item No.: 756-3503/050-020 Power cable; M12L plug; straight; 5-pole; Length: 2 m	 Item No.: 756-3513/050-020 Power cable; M12L plug; straight; 5-pole; Length: 2 m	 Item No.: 756-3503/050-050 Power cable; M12L plug; straight; 5-pole; Length: 5 m
 Item No.: 756-3513/050-050 Power cable; M12L plug; straight; 5-pole; Length: 5 m	 Item No.: 756-3503/050-075 Power cable; M12L plug; straight; 5-pole; Length: 7.5 m	 Item No.: 756-3513/050-075 Power cable; M12L plug; straight; 5-pole; Length: 7.5 m	 Item No.: 756-3502/050-100 Power cable; M12L socket; angled; 5-pole; Length: 10 m
 Item No.: 756-3512/050-100 Power cable; M12L socket; angled; 5-pole; Length: 10 m	 Item No.: 756-3502/050-150 Power cable; M12L socket; angled; 5-pole; Length: 15 m	 Item No.: 756-3512/050-150 Power cable; M12L socket; angled; 5-pole; Length: 15 m	 Item No.: 756-3502/050-020 Power cable; M12L socket; angled; 5-pole; Length: 2 m
 Item No.: 756-3512/050-020 Power cable; M12L socket; angled; 5-pole; Length: 2 m	 Item No.: 756-3502/050-050 Power cable; M12L socket; angled; 5-pole; Length: 5 m	 Item No.: 756-3512/050-050 Power cable; M12L socket; angled; 5-pole; Length: 5 m	 Item No.: 756-3502/050-075 Power cable; M12L socket; angled; 5-pole; Length: 7.5 m

1.2.1.6 Power cable

 Item No.: 756-3512/050-075 Power cable; M12L socket; angled; 5-pole; Length: 7.5 m	 Item No.: 756-3506/050-003 Power cable; M12L socket; angled; M12L plug; angled; 5-pole; Length: 0.3 m	 Item No.: 756-3506/050-005 Power cable; M12L socket; angled; M12L plug; angled; 5-pole; Length: 0.5 m	 Item No.: 756-3516/050-005 Power cable; M12L socket; angled; M12L plug; angled; 5-pole; Length: 0.5 m
 Item No.: 756-3506/050-010 Power cable; M12L socket; angled; M12L plug; angled; 5-pole; Length: 1 m	 Item No.: 756-3516/050-010 Power cable; M12L socket; angled; M12L plug; angled; 5-pole; Length: 1 m	 Item No.: 756-3506/050-100 Power cable; M12L socket; angled; M12L plug; angled; 5-pole; Length: 10 m	 Item No.: 756-3516/050-100 Power cable; M12L socket; angled; M12L plug; angled; 5-pole; Length: 10 m
 Item No.: 756-3506/050-150 Power cable; M12L socket; angled; M12L plug; angled; 5-pole; Length: 15 m	 Item No.: 756-3506/050-020 Power cable; M12L socket; angled; M12L plug; angled; 5-pole; Length: 2 m	 Item No.: 756-3516/050-020 Power cable; M12L socket; angled; M12L plug; angled; 5-pole; Length: 2 m	 Item No.: 756-3516/050-200 Power cable; M12L socket; angled; M12L plug; angled; 5-pole; Length: 20 m
 Item No.: 756-3516/050-400 Power cable; M12L socket; angled; M12L plug; angled; 5-pole; Length: 40 m	 Item No.: 756-3506/050-050 Power cable; M12L socket; angled; M12L plug; angled; 5-pole; Length: 5 m	 Item No.: 756-3516/050-050 Power cable; M12L socket; angled; M12L plug; angled; 5-pole; Length: 5 m	 Item No.: 756-3506/050-075 Power cable; M12L socket; angled; M12L plug; angled; 5-pole; Length: 7.5 m
 Item No.: 756-3516/050-075 Power cable; M12L socket; angled; M12L plug; angled; 5-pole; Length: 7.5 m	 Item No.: 756-3501/050-100 Power cable; M12L socket; straight; 5-pole; Length: 10 m	 Item No.: 756-3511/050-100 Power cable; M12L socket; straight; 5-pole; Length: 10 m	 Item No.: 756-3501/050-150 Power cable; M12L socket; straight; 5-pole; Length: 15 m
 Item No.: 756-3511/050-150 Power cable; M12L socket; straight; 5-pole; Length: 15 m	 Item No.: 756-3501/050-020 Power cable; M12L socket; straight; 5-pole; Length: 2 m	 Item No.: 756-3511/050-020 Power cable; M12L socket; straight; 5-pole; Length: 2 m	 Item No.: 756-3501/050-050 Power cable; M12L socket; straight; 5-pole; Length: 5 m
 Item No.: 756-3511/050-050 Power cable; M12L socket; straight; 5-pole; Length: 5 m	 Item No.: 756-3501/050-075 Power cable; M12L socket; straight; 5-pole; Length: 7.5 m	 Item No.: 756-3511/050-075 Power cable; M12L socket; straight; 5-pole; Length: 7.5 m	 Item No.: 756-3505/050-003 Power cable; M12L socket; straight; M12L plug; straight; 5-pole; Length: 0.3 m
 Item No.: 756-3505/050-005 Power cable; M12L socket; straight; M12L plug; straight; 5-pole; Length: 0.5 m	 Item No.: 756-3515/050-005 Power cable; M12L socket; straight; M12L plug; straight; 5-pole; Length: 0.5 m	 Item No.: 756-3505/050-010 Power cable; M12L socket; straight; M12L plug; straight; 5-pole; Length: 1 m	 Item No.: 756-3515/050-010 Power cable; M12L socket; straight; M12L plug; straight; 5-pole; Length: 1 m
 Item No.: 756-3505/050-100 Power cable; M12L socket; straight; M12L plug; straight; 5-pole; Length: 10 m	 Item No.: 756-3515/050-100 Power cable; M12L socket; straight; M12L plug; straight; 5-pole; Length: 10 m	 Item No.: 756-3505/050-150 Power cable; M12L socket; straight; M12L plug; straight; 5-pole; Length: 15 m	 Item No.: 756-3505/050-020 Power cable; M12L socket; straight; M12L plug; straight; 5-pole; Length: 2 m
 Item No.: 756-3515/050-020 Power cable; M12L socket; straight; M12L plug; straight; 5-pole; Length: 2 m	 Item No.: 756-3515/050-200 Power cable; M12L socket; straight; M12L plug; straight; 5-pole; Length: 20 m	 Item No.: 756-3515/050-300 Power cable; M12L socket; straight; M12L plug; straight; 5-pole; Length: 30 m	 Item No.: 756-3515/050-400 Power cable; M12L socket; straight; M12L plug; straight; 5-pole; Length: 40 m
 Item No.: 756-3505/050-050 Power cable; M12L socket; straight; M12L plug; straight; 5-pole; Length: 5 m	 Item No.: 756-3515/050-050 Power cable; M12L socket; straight; M12L plug; straight; 5-pole; Length: 5 m	 Item No.: 756-3505/050-075 Power cable; M12L socket; straight; M12L plug; straight; 5-pole; Length: 7.5 m	 Item No.: 756-3515/050-075 Power cable; M12L socket; straight; M12L plug; straight; 5-pole; Length: 7.5 m

1.2.1.7 Sensor/actuator cable



Item No.: 756-5312/040-015
Sensor/Actuator cable; M12A plug; angled; 4-pole; Length: 1.5 m

Item No.: 756-5312/040-100
Sensor/Actuator cable; M12A plug; angled; 4-pole; Length: 10 m

Item No.: 756-5312/040-050
Sensor/Actuator cable; M12A plug; angled; 4-pole; Length: 5 m

Item No.: 756-5311/040-015
Sensor/Actuator cable; M12A plug; straight; 4-pole; Length: 1.5 m



Item No.: 756-5311/040-100
Sensor/Actuator cable; M12A plug; straight; 4-pole; Length: 10 m

Item No.: 756-5311/040-050
Sensor/Actuator cable; M12A plug; straight; 4-pole; Length: 5 m

Item No.: 756-5404/040-010
Sensor/Actuator cable; M12A socket; angled; M12A plug; angled; 4-pole; Length: 1 m

Item No.: 756-5404/040-020
Sensor/Actuator cable; M12A socket; angled; M12A plug; angled; 4-pole; Length: 2 m



Item No.: 756-5403/040-010
Sensor/Actuator cable; M12A socket; angled; M12A plug; straight; 4-pole; Length: 1 m

Item No.: 756-5403/040-020
Sensor/Actuator cable; M12A socket; angled; M12A plug; straight; 4-pole; Length: 2 m

Item No.: 756-5402/040-010
Sensor/Actuator cable; M12A socket; straight; M12A plug; angled; 4-pole; Length: 1 m

Item No.: 756-5402/040-020
Sensor/Actuator cable; M12A socket; straight; M12A plug; angled; 4-pole; Length: 2 m



Item No.: 756-5401/040-010
Sensor/Actuator cable; M12A socket; straight; M12A plug; straight; 4-pole; Length: 1 m

Item No.: 756-5401/040-020
Sensor/Actuator cable; M12A socket; straight; M12A plug; straight; 4-pole; Length: 2 m

Item No.: 756-5510/040-010
Sensor/Actuator cable; M8 socket; angled; M12A plug; angled; 4-pole; Length: 1 m

Item No.: 756-5510/040-020
Sensor/Actuator cable; M8 socket; angled; M12A plug; angled; 4-pole; Length: 2 m



Item No.: 756-5509/040-010
Sensor/Actuator cable; M8 socket; angled; M12A plug; straight; 4-pole; Length: 1 m

Item No.: 756-5509/040-020
Sensor/Actuator cable; M8 socket; angled; M12A plug; straight; 4-pole; Length: 2 m

Item No.: 756-5508/040-010
Sensor/Actuator cable; M8 socket; straight; M12A plug; angled; 4-pole; Length: 1 m

Item No.: 756-5508/040-020
Sensor/Actuator cable; M8 socket; straight; M12A plug; angled; 4-pole; Length: 2 m



Item No.: 756-5507/040-010
Sensor/Actuator cable; M8 socket; straight; M12A plug; straight; 4-pole; Length: 1 m

Item No.: 756-5507/040-020
Sensor/Actuator cable; M8 socket; straight; M12A plug; straight; 4-pole; Length: 2 m