

# Data Sheet | Item Number: 765-1503/100-000

16-channel digital output; EtherNet/IP; DC 24 V / 2.0 A; 8xM12 connection; WideLine

<https://www.wago.com/765-1503/100-000>

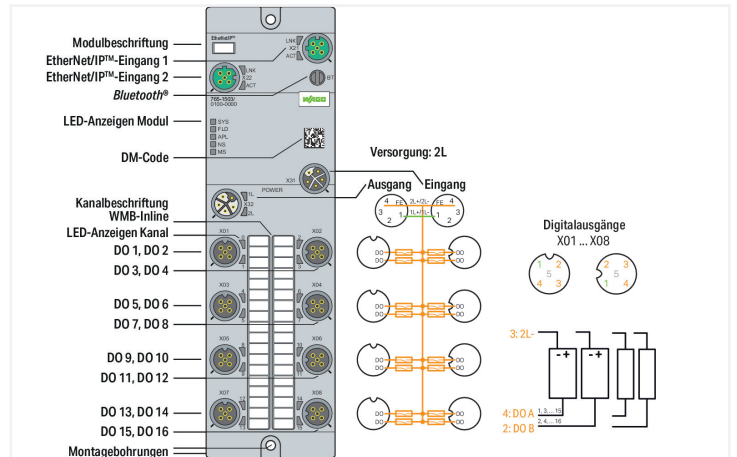

## Application area:

Decentralized processing of digital signals

This device controls digital field devices (e.g., actuators) and records digital signals (e.g., sensors) that are sent or received by a higher-level controller.

The device offers 16 digital outputs.

## Technical data

### Fieldbus

Communications	EtherNet/IP™ BOOTP, DHCP, DLR
Connection technology: communication/ fieldbus	2 x D-coded M12; 4-pole
Interface standard	10BASE-T/100BASE-TX; potential-free
Autonegotiation; autocrossover	Yes

### Device functions

Parameter	Output current Temperature
Diagnostics	Undervoltage; overcurrent; overload; overtemperature
Device functions	OPC UA server Bluetooth®
Visualization	Web server Android/iOS app

### Digital inputs/outputs

Number of digital outputs	16
Connection technology: inputs/outputs	8 x A-coded M12; 5-pole
Signal type (voltage)	24 VDC
Output current (per channel)	2 A (typ.) for DO
Supply current per port	1L/2L: 4 A (max.)

### Supply (module)

Connection technology: supply	2 x L-coded M12; 5-pole
Supply voltage	24 VDC (18 ... 31.2 V); 1L/2L
Current consumption (max.)	16000 mA
Current consumption (note)	per supply line; overload- and short-circuit-protected
Reverse voltage protection	Yes

### Physical data

Width	60 mm / 2.362 inches
Height	30 mm / 1.181 inches
Depth	210 mm / 8.268 inches

### Mechanical data

Weight	610 g
Conformity marking	CE

### Environmental requirements

Ambient temperature (operation)	-25 ... +70 °C
Ambient temperature (storage)	-40 ... +80 °C
Protection type	IP67
Protection class	III per EN 61140, IEC 61140, VDE 0140-1
Operating altitude	0 ... 2000 m / 0 ... 6562 ft
Pollution degree	3 (EN 60664-1)
Overvoltage category	II (EN 60664-1)
Relative humidity (without condensation)	95 %
Vibration resistance	5g per IEC 60068-2-6
Shock resistance	Short-term: 50g/11 ms/half-sine per IEC 60068-2-27; Long-term: 30g/6 ms/half-sine per IEC 60068-2-29
EMC immunity to interference	per EN 61000-6-2
EMC emission of interference	per EN 61000-6-4

### Commercial data

ETIM 9.0	EC001599
ETIM 8.0	EC001599
PU (SPU)	1 pcs
Packaging type	Box
Country of origin	DE
GTIN	4066966063097
Customs tariff number	85371098990

### Environmental Product Compliance

RoHS Compliance Status	Compliant, No Exemption
------------------------	-------------------------

## Approvals / Certificates

### General approvals



Approval	Standard	Certificate Name
EAC GZO Almaty Standart	TP TC 020/2011	EAC CoC 03083
KC National Radio Research Agency	Article 58-2, Clause 3	KC R-R-W43-FB765
UL Underwriters Laboratories Inc. (ORDINARY LOCATIONS)	-	E175199

### Declarations of conformity and manufacturer's declarations

Approval	Standard	Certificate Name
EU-Declaration of Conformity WAGO GmbH & Co. KG	-	-

## Downloads

### Environmental Product Compliance

#### Compliance Search

Environmental Product Compliance  
765-1503/100-000



## Documentation

### Manual

Product Manual 16-Channel Digital Output; EtherNet/IP  
V 2.0.0  
19.07.2022  
pdf  
7686.43 KB



### System Description

WAGO I/O System Field; General Product Information  
pdf  
1009.23 KB



## CAD/CAE-Data

### CAD data

2D/3D Models  
765-1503/100-000



### CAE data

EPLAN Data Portal  
765-1503/100-000



## Runtime Software

### Firmware

0765-x5xx, Ethernet/IP IO-Field  
V 04  
02.02.2023  
zip  
1546.91 KB



**Libraries**

Device Description File				
750-915; EDS-Dateien for EthernetIP / Serie 750, 765 and 767	12	09.07.2021	zip 164.42 KB	
Gerätebeschreibungsdateien 765-45xx, 765-15xx, EtherNet/IP	V1_1_0_22		zip 74.02 KB	

**1 Compatible Products**

**1.1 Required Accessories**

**1.1.1 Cover**

**1.1.1.1 Cover**



[Item No.: 756-8103](#)  
M12 protective cap; for unused plugs

[Item No.: 756-8102](#)  
M12 protective cap; for unused sockets

**1.1.2 Marking**

**1.1.2.1 Marker**



[Item No.: 2009-115](#)  
WMB-Inline; for Smart Printer; 1500 pieces on roll; stretchable 5 - 5.2 mm; plain; snap-on type; white

**1.1.2.2 Marking strip**



[Item No.: 2009-110](#)  
Marking strips; for Smart Printer; on reel; not stretchable; plain; snap-on type; white

**1.1.3 Tool**

**1.1.3.1 Assembly tool**



[Item No.: 206-701](#)  
Torque wrench M8 and M12; Assembly kit

1.2 Optional Accessories

1.2.1 Cables and connectors

1.2.1.1 Adapter



[Item No.: 756-9503/040-000](#)  
Accessories; 4-pole

[Item No.: 756-9504/040-000](#)  
Accessories; 4-pole

1.2.1.2 Configurable Connector



[Item No.: 756-9205/040-000](#)  
Fitted pluggable connector; 4-pole; M12 plug, right angle; Spring

[Item No.: 756-9202/040-000](#)  
Fitted pluggable connector; 4-pole; M12 plug, straight, A-coded; Spring

[Item No.: 756-9701/050-000](#)  
Fitted pluggable connector; 5-pole, shielded; M12 plug, straight; IDC technology

[Item No.: 756-9711/050-000](#)  
Fitted pluggable connector; 5-pole, shielded; M12 socket, straight; IDC technology

1.2.1.3 Configurable Shielded Connector



[Item No.: 756-9501/040-000](#)  
Accessories; M12 plug, right angle; 4-pole

[Item No.: 756-9501/060-000](#)  
Fitted pluggable connector; 4-pole, shielded; M12 plug, straight, D-coded; Spring

1.2.1.4 Distribution connector



[Item No.: 756-9301/040-000](#)  
Accessories; 4-pole

[Item No.: 756-9301/050-000](#)  
Accessories; 5-pole

[Item No.: 756-5517/040-010](#)  
Sensor/Actuator cable; 2xM12 socket; angled; M12A plug; straight; 4-pole; Length: 1 m

[Item No.: 756-5517/040-020](#)  
Sensor/Actuator cable; 2xM12 socket; angled; M12A plug; straight; 4-pole; Length: 2 m



[Item No.: 756-5516/040-010](#)  
Sensor/Actuator cable; 2xM12 socket; straight; M12A plug; straight; 4-pole; Length: 1 m

[Item No.: 756-5516/040-020](#)  
Sensor/Actuator cable; 2xM12 socket; straight; M12A plug; straight; 4-pole; Length: 2 m

[Item No.: 756-5514/040-010](#)  
Sensor/Actuator cable; 2xM8 socket; angled; M12A plug; straight; 4-pole; Length: 1 m

[Item No.: 756-5514/040-020](#)  
Sensor/Actuator cable; 2xM8 socket; angled; M12A plug; straight; 4-pole; Length: 2 m



[Item No.: 756-5513/040-010](#)  
Sensor/Actuator cable; 2xM8 socket; straight; M12A plug; straight; 4-pole; Length: 1 m

[Item No.: 756-5513/040-020](#)  
Sensor/Actuator cable; 2xM8 socket; straight; M12A plug; straight; 4-pole; Length: 2 m

1.2.1.5 ETHERNET/PROFINET cable



[Item No.: 756-1202/060-100](#)  
ETHERNET cable; M12D plug; angled; 4-pole; Length: 10 m

[Item No.: 756-1202/060-020](#)  
ETHERNET cable; M12D plug; angled; 4-pole; Length: 2 m

[Item No.: 756-1202/060-200](#)  
ETHERNET cable; M12D plug; angled; 4-pole; Length: 20 m

[Item No.: 756-1202/060-050](#)  
ETHERNET cable; M12D plug; angled; 4-pole; Length: 5 m



[Item No.: 756-1204/060-010](#)  
ETHERNET cable; M12D plug; angled; M12D plug; angled; 4-pole; Length: 1 m

[Item No.: 756-1204/060-100](#)  
ETHERNET cable; M12D plug; angled; M12D plug; angled; 4-pole; Length: 10 m

[Item No.: 756-1204/060-020](#)  
ETHERNET cable; M12D plug; angled; M12D plug; angled; 4-pole; Length: 2 m

[Item No.: 756-1204/060-200](#)  
ETHERNET cable; M12D plug; angled; M12D plug; angled; 4-pole; Length: 20 m



[Item No.: 756-1204/060-030](#)  
ETHERNET cable; M12D plug; angled; M12D plug; angled; 4-pole; Length: 3 m

[Item No.: 756-1204/060-050](#)  
ETHERNET cable; M12D plug; angled; M12D plug; angled; 4-pole; Length: 5 m

[Item No.: 756-1201/060-100](#)  
ETHERNET cable; M12D plug; straight; 4-pole; Length: 10 m

[Item No.: 756-1201/060-020](#)  
ETHERNET cable; M12D plug; straight; 4-pole; Length: 2 m

1.2.1.5 ETHERNET/PROFINET cable



**Item No.: 756-1201/060-200**  
ETHERNET cable; M12D plug; straight; 4-pole; Length: 20 m

**Item No.: 756-1201/060-050**  
ETHERNET cable; M12D plug; straight; 4-pole; Length: 5 m

**Item No.: 756-1203/060-100**  
ETHERNET cable; M12D plug; straight; M12D plug; straight; 4-pole; Length: 10 m

**Item No.: 756-1203/060-020**  
ETHERNET cable; M12D plug; straight; M12D plug; straight; 4-pole; Length: 2 m



**Item No.: 756-1203/060-200**  
ETHERNET cable; M12D plug; straight; M12D plug; straight; 4-pole; Length: 20 m

**Item No.: 756-1203/060-050**  
ETHERNET cable; M12D plug; straight; M12D plug; straight; 4-pole; Length: 5 m

1.2.1.6 Power cable



**Item No.: 756-3504/050-100**  
Power cable; M12L plug; angled; 5-pole; Length: 10 m

**Item No.: 756-3514/050-100**  
Power cable; M12L plug; angled; 5-pole; Length: 10 m

**Item No.: 756-3504/050-150**  
Power cable; M12L plug; angled; 5-pole; Length: 15 m

**Item No.: 756-3514/050-150**  
Power cable; M12L plug; angled; 5-pole; Length: 15 m



**Item No.: 756-3504/050-020**  
Power cable; M12L plug; angled; 5-pole; Length: 2 m

**Item No.: 756-3504/050-050**  
Power cable; M12L plug; angled; 5-pole; Length: 5 m

**Item No.: 756-3514/050-050**  
Power cable; M12L plug; angled; 5-pole; Length: 5 m

**Item No.: 756-3504/050-075**  
Power cable; M12L plug; angled; 5-pole; Length: 7.5 m



**Item No.: 756-3514/050-075**  
Power cable; M12L plug; angled; 5-pole; Length: 7.5 m

**Item No.: 756-3503/050-100**  
Power cable; M12L plug; straight; 5-pole; Length: 10 m

**Item No.: 756-3513/050-100**  
Power cable; M12L plug; straight; 5-pole; Length: 10 m

**Item No.: 756-3503/050-150**  
Power cable; M12L plug; straight; 5-pole; Length: 15 m



**Item No.: 756-3513/050-150**  
Power cable; M12L plug; straight; 5-pole; Length: 15 m

**Item No.: 756-3503/050-020**  
Power cable; M12L plug; straight; 5-pole; Length: 2 m

**Item No.: 756-3513/050-020**  
Power cable; M12L plug; straight; 5-pole; Length: 2 m

**Item No.: 756-3503/050-050**  
Power cable; M12L plug; straight; 5-pole; Length: 5 m



**Item No.: 756-3513/050-050**  
Power cable; M12L plug; straight; 5-pole; Length: 5 m

**Item No.: 756-3503/050-075**  
Power cable; M12L plug; straight; 5-pole; Length: 7.5 m

**Item No.: 756-3513/050-075**  
Power cable; M12L plug; straight; 5-pole; Length: 7.5 m

**Item No.: 756-3502/050-100**  
Power cable; M12L socket; angled; 5-pole; Length: 10 m



**Item No.: 756-3512/050-100**  
Power cable; M12L socket; angled; 5-pole; Length: 10 m

**Item No.: 756-3502/050-150**  
Power cable; M12L socket; angled; 5-pole; Length: 15 m

**Item No.: 756-3512/050-150**  
Power cable; M12L socket; angled; 5-pole; Length: 15 m

**Item No.: 756-3502/050-020**  
Power cable; M12L socket; angled; 5-pole; Length: 2 m



**Item No.: 756-3512/050-020**  
Power cable; M12L socket; angled; 5-pole; Length: 2 m

**Item No.: 756-3502/050-050**  
Power cable; M12L socket; angled; 5-pole; Length: 5 m

**Item No.: 756-3512/050-050**  
Power cable; M12L socket; angled; 5-pole; Length: 5 m

**Item No.: 756-3502/050-075**  
Power cable; M12L socket; angled; 5-pole; Length: 7.5 m



**Item No.: 756-3512/050-075**  
Power cable; M12L socket; angled; 5-pole; Length: 7.5 m

**Item No.: 756-3506/050-003**  
Power cable; M12L socket; angled; M12L plug; angled; 5-pole; Length: 0.3 m

**Item No.: 756-3506/050-005**  
Power cable; M12L socket; angled; M12L plug; angled; 5-pole; Length: 0.5 m

**Item No.: 756-3516/050-005**  
Power cable; M12L socket; angled; M12L plug; angled; 5-pole; Length: 0.5 m



**Item No.: 756-3506/050-010**  
Power cable; M12L socket; angled; M12L plug; angled; 5-pole; Length: 1 m

**Item No.: 756-3516/050-010**  
Power cable; M12L socket; angled; M12L plug; angled; 5-pole; Length: 1 m

**Item No.: 756-3506/050-100**  
Power cable; M12L socket; angled; M12L plug; angled; 5-pole; Length: 10 m

**Item No.: 756-3516/050-100**  
Power cable; M12L socket; angled; M12L plug; angled; 5-pole; Length: 10 m



































**Item No.: 756-3506/050-150**  
Power cable; M12L socket; angled; M12L plug; angled; 5-pole; Length: 15 m

**Item No.: 756-3506/050-020**  
Power cable; M12L socket; angled; M12L plug; angled; 5-pole; Length: 2 m

















**Item No.: 756-3516/050-020**  
Power cable; M12L socket; angled; M12L plug; angled; 5-pole; Length: 2 m

**Item No.: 756-3516/050-200**  
Power cable; M12L socket; angled; M12L plug; angled; 5-pole; Length: 20 m

1.2.1.6 Power cable

 <b>Item No.: 756-3516/050-400</b> Power cable; M12L socket; angled; M12L plug; angled; 5-pole; Length: 40 m	 <b>Item No.: 756-3506/050-050</b> Power cable; M12L socket; angled; M12L plug; angled; 5-pole; Length: 5 m	 <b>Item No.: 756-3516/050-050</b> Power cable; M12L socket; angled; M12L plug; angled; 5-pole; Length: 5 m	 <b>Item No.: 756-3506/050-075</b> Power cable; M12L socket; angled; M12L plug; angled; 5-pole; Length: 7.5 m
 <b>Item No.: 756-3516/050-075</b> Power cable; M12L socket; angled; M12L plug; angled; 5-pole; Length: 7.5 m	 <b>Item No.: 756-3501/050-100</b> Power cable; M12L socket; straight; 5-pole; Length: 10 m	 <b>Item No.: 756-3511/050-100</b> Power cable; M12L socket; straight; 5-pole; Length: 10 m	 <b>Item No.: 756-3501/050-150</b> Power cable; M12L socket; straight; 5-pole; Length: 15 m
 <b>Item No.: 756-3511/050-150</b> Power cable; M12L socket; straight; 5-pole; Length: 15 m	 <b>Item No.: 756-3501/050-020</b> Power cable; M12L socket; straight; 5-pole; Length: 2 m	 <b>Item No.: 756-3511/050-020</b> Power cable; M12L socket; straight; 5-pole; Length: 2 m	 <b>Item No.: 756-3501/050-050</b> Power cable; M12L socket; straight; 5-pole; Length: 5 m
 <b>Item No.: 756-3511/050-050</b> Power cable; M12L socket; straight; 5-pole; Length: 5 m	 <b>Item No.: 756-3501/050-075</b> Power cable; M12L socket; straight; 5-pole; Length: 7.5 m	 <b>Item No.: 756-3511/050-075</b> Power cable; M12L socket; straight; 5-pole; Length: 7.5 m	 <b>Item No.: 756-3505/050-003</b> Power cable; M12L socket; straight; M12L plug; straight; 5-pole; Length: 0.3 m
 <b>Item No.: 756-3505/050-005</b> Power cable; M12L socket; straight; M12L plug; straight; 5-pole; Length: 0.5 m	 <b>Item No.: 756-3515/050-005</b> Power cable; M12L socket; straight; M12L plug; straight; 5-pole; Length: 0.5 m	 <b>Item No.: 756-3505/050-010</b> Power cable; M12L socket; straight; M12L plug; straight; 5-pole; Length: 1 m	 <b>Item No.: 756-3515/050-010</b> Power cable; M12L socket; straight; M12L plug; straight; 5-pole; Length: 1 m
 <b>Item No.: 756-3505/050-100</b> Power cable; M12L socket; straight; M12L plug; straight; 5-pole; Length: 10 m	 <b>Item No.: 756-3515/050-100</b> Power cable; M12L socket; straight; M12L plug; straight; 5-pole; Length: 10 m	 <b>Item No.: 756-3505/050-150</b> Power cable; M12L socket; straight; M12L plug; straight; 5-pole; Length: 15 m	 <b>Item No.: 756-3505/050-020</b> Power cable; M12L socket; straight; M12L plug; straight; 5-pole; Length: 2 m
 <b>Item No.: 756-3515/050-020</b> Power cable; M12L socket; straight; M12L plug; straight; 5-pole; Length: 2 m	 <b>Item No.: 756-3515/050-200</b> Power cable; M12L socket; straight; M12L plug; straight; 5-pole; Length: 20 m	 <b>Item No.: 756-3515/050-300</b> Power cable; M12L socket; straight; M12L plug; straight; 5-pole; Length: 30 m	 <b>Item No.: 756-3515/050-400</b> Power cable; M12L socket; straight; M12L plug; straight; 5-pole; Length: 40 m
 <b>Item No.: 756-3505/050-050</b> Power cable; M12L socket; straight; M12L plug; straight; 5-pole; Length: 5 m	 <b>Item No.: 756-3515/050-050</b> Power cable; M12L socket; straight; M12L plug; straight; 5-pole; Length: 5 m	 <b>Item No.: 756-3505/050-075</b> Power cable; M12L socket; straight; M12L plug; straight; 5-pole; Length: 7.5 m	 <b>Item No.: 756-3515/050-075</b> Power cable; M12L socket; straight; M12L plug; straight; 5-pole; Length: 7.5 m

1.2.1.7 Sensor/actuator cable

 <b>Item No.: 756-5312/040-015</b> Sensor/Actuator cable; M12A plug; angled; 4-pole; Length: 1.5 m	 <b>Item No.: 756-5312/040-100</b> Sensor/Actuator cable; M12A plug; angled; 4-pole; Length: 10 m	 <b>Item No.: 756-5312/040-050</b> Sensor/Actuator cable; M12A plug; angled; 4-pole; Length: 5 m	 <b>Item No.: 756-5311/040-015</b> Sensor/Actuator cable; M12A plug; straight; 4-pole; Length: 1.5 m
 <b>Item No.: 756-5311/040-100</b> Sensor/Actuator cable; M12A plug; straight; 4-pole; Length: 10 m	 <b>Item No.: 756-5311/040-050</b> Sensor/Actuator cable; M12A plug; straight; 4-pole; Length: 5 m	 <b>Item No.: 756-5404/040-010</b> Sensor/Actuator cable; M12A socket; straight; M12A plug; angled; 4-pole; Length: 1 m	 <b>Item No.: 756-5404/040-020</b> Sensor/Actuator cable; M12A socket; angled; M12A plug; angled; 4-pole; Length: 2 m
 <b>Item No.: 756-5403/040-010</b> Sensor/Actuator cable; M12A socket; angled; M12A plug; straight; 4-pole; Length: 1 m	 <b>Item No.: 756-5403/040-020</b> Sensor/Actuator cable; M12A socket; angled; M12A plug; straight; 4-pole; Length: 2 m	 <b>Item No.: 756-5402/040-010</b> Sensor/Actuator cable; M12A socket; straight; M12A plug; angled; 4-pole; Length: 1 m	 <b>Item No.: 756-5402/040-020</b> Sensor/Actuator cable; M12A socket; straight; M12A plug; angled; 4-pole; Length: 2 m
 <b>Item No.: 756-5401/040-010</b> Sensor/Actuator cable; M12A socket; straight; M12A plug; straight; 4-pole; Length: 1 m	 <b>Item No.: 756-5401/040-020</b> Sensor/Actuator cable; M12A socket; straight; M12A plug; straight; 4-pole; Length: 2 m	 <b>Item No.: 756-5510/040-010</b> Sensor/Actuator cable; M8 socket; angled; M12A plug; angled; 4-pole; Length: 1 m	 <b>Item No.: 756-5510/040-020</b> Sensor/Actuator cable; M8 socket; angled; M12A plug; angled; 4-pole; Length: 2 m

1.2.1.7 Sensor/actuator cable



Item No.: 756-5509/040-010

Sensor/Actuator cable; M8 socket; angled; M12A plug; straight; 4-pole; Length: 1 m



Item No.: 756-5509/040-020

Sensor/Actuator cable; M8 socket; angled; M12A plug; straight; 4-pole; Length: 2 m



Item No.: 756-5508/040-010

Sensor/Actuator cable; M8 socket; straight; M12A plug; angled; 4-pole; Length: 1 m



Item No.: 756-5508/040-020

Sensor/Actuator cable; M8 socket; straight; M12A plug; angled; 4-pole; Length: 2 m



Item No.: 756-5507/040-010

Sensor/Actuator cable; M8 socket; straight; M12A plug; straight; 4-pole; Length: 1 m



Item No.: 756-5507/040-020

Sensor/Actuator cable; M8 socket; straight; M12A plug; straight; 4-pole; Length: 2 m