

# Data Sheet | Item Number: 765-1102/100-000

16-channel digital input/output; Profinet; DC 24 V / 2.0 A; 8xM12 connection; Wide-Line

<https://www.wago.com/765-1102/100-000>

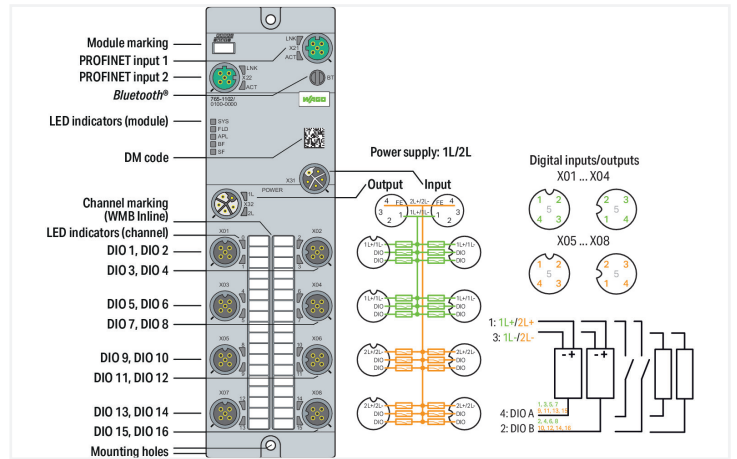

## Application:

Decentralized processing of digital signals

This device records and controls digital field device signals (e.g., sensors and actuators) that are received or controlled by a higher-level controller.

The device offers 16 digital inputs/outputs.

Technical data		Device functions	
<b>Fieldbus</b>		<b>Parameter</b>	
Communications	PROFINET PROFINET IO device; 2-port switch, LLDP, MRP, SNMP	Input filter	Output current
Connection technology: communication/fieldbus	2 x D-coded M12; 4-pole	Diagnostics	Temperature
Interface standard	10BASE-T/100BASE-TX; potential-free	Device functions	Undervoltage; overcurrent; overload; overtemperature
Autonegotiation; autocrossover	Yes	Visualization	Bluetooth® OPC UA server
PROFINET IO features	PROFINET IO device; 2-port switch, LLDP, MRP, SNMP		Android/iOS app Web server

### Digital inputs/outputs

Number of digital inputs	16
Number of digital outputs	16
Connection technology: inputs/outputs	8 x A-coded M12; 5-pole
Signal type (voltage)	24 VDC
Input characteristic	high-side switching Type 3, per IEC 61131-2
Input filter	0.2 ... 20 ms
Output current (per channel)	2 A (typ.) for DO
Supply current per port	1L/2L: 4 A (max.)

### Supply (module)

Connection technology: supply	2 x L-coded M12; 5-pole
Supply voltage	24 VDC (18 ... 31.2 V); 1L/2L
Current consumption (max.)	16000 mA
Current consumption (note)	per supply line; overload- and short-circuit-protected
Reverse voltage protection	Yes

### Physical data

Width	60 mm / 2.362 inches
Height	30 mm / 1.181 inches
Depth	210 mm / 8.268 inches

### Mechanical data

Weight	610 g
Conformity marking	CE

### Environmental requirements

Ambient temperature (operation)	-25 ... +70 °C
Ambient temperature (storage)	-40 ... +80 °C
Protection type	IP67
Protection class	III per EN 61140, IEC 61140, VDE 0140-1
Operating altitude	0 ... 2000 m / 0 ... 6562 ft
Pollution degree	3 (EN 60664-1)
Overvoltage category	II (EN 60664-1)
Relative humidity (without condensation)	95 %
Vibration resistance	5g per IEC 60068-2-6
Shock resistance	Short-term: 50g/11 ms/half-sine per IEC 60068-2-27; Long-term: 30g/6 ms/half-sine per IEC 60068-2-29
EMC immunity to interference	per EN 61000-6-2
EMC emission of interference	per EN 61000-6-4

### Commercial data

ETIM 9.0	EC001599
ETIM 8.0	EC001599
PU (SPU)	1 pcs
Packaging type	Box
Country of origin	DE
GTIN	4055143949965
Customs tariff number	85371098990

**Environmental Product Compliance**

CAS-No.	7439-92-1
REACH Candidate List Substance	Lead
RoHS Compliance Status	Compliant,With Exemption
RoHS Exemption	6(c) 7(a) 7(c)-I
SCIP notification number (Austria)	316e63bf-d533-4834-8825-c31b9f3fc712
SCIP notification number (Belgium)	6d277029-5347-4551-94f2-fa10a9dd2342
SCIP notification number (Bulgaria)	0f7b3fee-4e75-466f-b6fa-eb1c8fe11e07
SCIP notification number (Czech Republic)	2ea176d9-e06c-449f-996a-349c8c2b4731
SCIP notification number (Denmark)	56087481-8142-4d00-95fb-c8df62e986a7
SCIP notification number (Finland)	3367c9a8-17ae-4dd2-9ad3-241f92599e77
SCIP notification number (France)	86c16806-356b-487d-bd5f-e3760e6a5116
SCIP notification number (Germany)	1858bb32-546d-42d4-94eb-199f5258105c
SCIP notification number (Hungary)	1a3fe7b0-a232-43d7-926a-05a158eac769
SCIP notification number (Italy)	44e49bf2-baff-4d87-8a23-5eaf40aa15f
SCIP notification number (Netherlands)	b52634b5-7d36-45f8-875d-8b198b46841d
SCIP notification number (Poland)	afbcb304-812f-4a5f-8078-7fa17279616e
SCIP notification number (Romania)	8adee8be-e5a8-41be-9b50-d303701ff954
SCIP notification number (Sweden)	9466b03d-8320-4ed2-a9d8-448726aa55f3

**Approvals / Certificates**

General approvals			Declarations of conformity and manufacturer's declarations		
Approval	Standard	Certificate Name	Approval	Standard	Certificate Name
EAC GZO Almaty Standart	TP TC 020/2011	EAC CoC 03083	EU-Declaration of Confor- mity WAGO GmbH & Co. KG	-	-
KC National Radio Research Agency	Article 58-2, Clause 3	KC R-R-W43-FB765			
UL Underwriters Laboratories Inc. (ORDINARY LOCATI- ONS)	-	E175199			

**Downloads**

**Environmental Product Compliance**

<b>Compliance Search</b>
Environmental Product Compliance 765-1102/100-000

## Documentation

Manual			
Product Manual 16-Channel Digital Input/Output; Profinet	V 2.2.0 19.07.2022	pdf 8069.81 KB	<a href="#">↓</a>

System Description	
WAGO I/O System Field; General Product Information	pdf 1009.23 KB <a href="#">↓</a>

Instruction Leaflet			
I/O System Field package insert	15.12.2021	pdf 1083.98 KB	<a href="#">↓</a>

## CAD/CAE-Data

CAD data	
2D/3D Models 765-1102/100-000	<a href="#">↓</a>

CAE data	
EPLAN Data Portal 765-1102/100-000	<a href="#">↓</a>
ZUKEN Portal 765-1102/100-000	<a href="#">↓</a>

## Runtime Software

Firmware			
0765-x1xx, Profinet IO-Field	V 04 02.02.2023	zip 1595.41 KB	<a href="#">↓</a>

## Libraries

Device Description File			
750-916; GSD files of version 2.x for PROFINET/ series 750/753, 765, 767 and 852	3.0 15.01.2023	zip 2582.40 KB	<a href="#">↓</a>
Gerätebeschreibungsdateien 765-41xx, 765-11xx, PROFINET	V1_1_0_22	zip 27.85 KB	<a href="#">↓</a>

## 1 Compatible Products

### 1.1 Required Accessories

#### 1.1.1 Cover

##### 1.1.1.1 Cover



[Item No.: 756-8103](#)  
M12 protective cap; for unused plugs

[Item No.: 756-8102](#)  
M12 protective cap; for unused sockets

## 1.1.2 Marking

### 1.1.2.1 Marker



**Item No.: 2009-115**

WMB-Inline; for Smart Printer; 1500 pieces on roll; stretchable 5 - 5.2 mm; plain; snap-on type; white

### 1.1.2.2 Marking strip



**Item No.: 2009-110**

Marking strips; for Smart Printer; on reel; not stretchable; plain; snap-on type; white

## 1.1.3 Tool

### 1.1.3.1 Assembly tool



**Item No.: 206-701**

Torque wrench M8 and M12; Assembly kit

## 1.2 Optional Accessories

### 1.2.1 Cables and connectors

#### 1.2.1.1 Adapter



**Item No.: 756-9503/040-000**

Accessories; 4-pole



**Item No.: 756-9504/040-000**

Accessories; 4-pole

#### 1.2.1.2 Configurable Connector



**Item No.: 756-9205/040-000**

Fitted pluggable connector; 4-pole; M12 plug, right angle; Spring



**Item No.: 756-9202/040-000**

Fitted pluggable connector; 4-pole; M12 plug, straight, A-coded; Spring



**Item No.: 756-9701/050-000**

Fitted pluggable connector; 5-pole, shielded; M12 plug, straight; IDC technology



**Item No.: 756-9711/050-000**

Fitted pluggable connector; 5-pole, shielded; M12 socket, straight; IDC technology

#### 1.2.1.3 Configurable Shielded Connector



**Item No.: 756-9501/040-000**

Accessories; M12 plug, right angle; 4-pole



**Item No.: 756-9501/060-000**

Fitted pluggable connector; 4-pole, shielded; M12 plug, straight, D-coded; Spring

1.2.1.4 Distribution connector



**Item No.: 756-9301/040-000**  
Accessories; 4-pole



**Item No.: 756-9301/050-000**  
Accessories; 5-pole



**Item No.: 756-5517/040-010**  
Sensor/Actuator cable; 2xM12 socket; angled; M12A plug; straight; 4-pole; Length: 1 m



**Item No.: 756-5517/040-020**  
Sensor/Actuator cable; 2xM12 socket; angled; M12A plug; straight; 4-pole; Length: 2 m



**Item No.: 756-5516/040-010**  
Sensor/Actuator cable; 2xM12 socket; straight; M12A plug; straight; 4-pole; Length: 1 m



**Item No.: 756-5516/040-020**  
Sensor/Actuator cable; 2xM12 socket; straight; M12A plug; straight; 4-pole; Length: 2 m



**Item No.: 756-5514/040-010**  
Sensor/Actuator cable; 2xM8 socket; angled; M12A plug; straight; 4-pole; Length: 1 m



**Item No.: 756-5514/040-020**  
Sensor/Actuator cable; 2xM8 socket; angled; M12A plug; straight; 4-pole; Length: 2 m



**Item No.: 756-5513/040-010**  
Sensor/Actuator cable; 2xM8 socket; straight; M12A plug; straight; 4-pole; Length: 1 m



**Item No.: 756-5513/040-020**  
Sensor/Actuator cable; 2xM8 socket; straight; M12A plug; straight; 4-pole; Length: 2 m

1.2.1.5 ETHERNET/PROFINET cable



**Item No.: 756-1202/060-100**  
ETHERNET cable; M12D plug; angled; 4-pole; Length: 10 m



**Item No.: 756-1202/060-020**  
ETHERNET cable; M12D plug; angled; 4-pole; Length: 2 m



**Item No.: 756-1202/060-200**  
ETHERNET cable; M12D plug; angled; 4-pole; Length: 20 m



**Item No.: 756-1202/060-050**  
ETHERNET cable; M12D plug; angled; 4-pole; Length: 5 m



**Item No.: 756-1204/060-010**  
ETHERNET cable; M12D plug; angled; M12D plug; angled; 4-pole; Length: 1 m



**Item No.: 756-1204/060-100**  
ETHERNET cable; M12D plug; angled; M12D plug; angled; 4-pole; Length: 10 m



**Item No.: 756-1204/060-020**  
ETHERNET cable; M12D plug; angled; M12D plug; angled; 4-pole; Length: 2 m



**Item No.: 756-1204/060-200**  
ETHERNET cable; M12D plug; angled; M12D plug; angled; 4-pole; Length: 20 m



**Item No.: 756-1204/060-030**  
ETHERNET cable; M12D plug; angled; M12D plug; angled; 4-pole; Length: 3 m



**Item No.: 756-1204/060-050**  
ETHERNET cable; M12D plug; angled; M12D plug; angled; 4-pole; Length: 5 m



**Item No.: 756-1201/060-100**  
ETHERNET cable; M12D plug; straight; 4-pole; Length: 10 m



**Item No.: 756-1201/060-020**  
ETHERNET cable; M12D plug; straight; 4-pole; Length: 2 m



**Item No.: 756-1201/060-200**  
ETHERNET cable; M12D plug; straight; 4-pole; Length: 20 m



**Item No.: 756-1201/060-050**  
ETHERNET cable; M12D plug; straight; 4-pole; Length: 5 m



**Item No.: 756-1203/060-100**  
ETHERNET cable; M12D plug; straight; M12D plug; straight; 4-pole; Length: 10 m



**Item No.: 756-1203/060-020**  
ETHERNET cable; M12D plug; straight; M12D plug; straight; 4-pole; Length: 2 m



**Item No.: 756-1203/060-200**  
ETHERNET cable; M12D plug; straight; M12D plug; straight; 4-pole; Length: 20 m



**Item No.: 756-1203/060-050**  
ETHERNET cable; M12D plug; straight; M12D plug; straight; 4-pole; Length: 5 m

1.2.1.6 Power cable



**Item No.: 756-3504/050-100**  
Power cable; M12L plug; angled; 5-pole; Length: 10 m



**Item No.: 756-3514/050-100**  
Power cable; M12L plug; angled; 5-pole; Length: 10 m



**Item No.: 756-3504/050-150**  
Power cable; M12L plug; angled; 5-pole; Length: 15 m



**Item No.: 756-3514/050-150**  
Power cable; M12L plug; angled; 5-pole; Length: 15 m



**Item No.: 756-3504/050-020**  
Power cable; M12L plug; angled; 5-pole; Length: 2 m



**Item No.: 756-3504/050-050**  
Power cable; M12L plug; angled; 5-pole; Length: 5 m



**Item No.: 756-3514/050-050**  
Power cable; M12L plug; angled; 5-pole; Length: 5 m



**Item No.: 756-3504/050-075**  
Power cable; M12L plug; angled; 5-pole; Length: 7.5 m



**Item No.: 756-3514/050-075**  
Power cable; M12L plug; angled; 5-pole; Length: 7.5 m



**Item No.: 756-3503/050-100**  
Power cable; M12L plug; straight; 5-pole; Length: 10 m















































**Item No.: 756-3513/050-100**  
Power cable; M12L plug; straight; 5-pole; Length: 10 m



**Item No.: 756-3503/050-150**  
Power cable; M12L plug; straight; 5-pole; Length: 15 m

1.2.1.6 Power cable

 <b>Item No.: 756-3513/050-150</b> Power cable; M12L plug; straight; 5-pole; Length: 15 m	 <b>Item No.: 756-3503/050-020</b> Power cable; M12L plug; straight; 5-pole; Length: 2 m	 <b>Item No.: 756-3513/050-020</b> Power cable; M12L plug; straight; 5-pole; Length: 2 m	 <b>Item No.: 756-3503/050-050</b> Power cable; M12L plug; straight; 5-pole; Length: 5 m
 <b>Item No.: 756-3513/050-050</b> Power cable; M12L plug; straight; 5-pole; Length: 5 m	 <b>Item No.: 756-3503/050-075</b> Power cable; M12L plug; straight; 5-pole; Length: 7.5 m	 <b>Item No.: 756-3513/050-075</b> Power cable; M12L plug; straight; 5-pole; Length: 7.5 m	 <b>Item No.: 756-3502/050-100</b> Power cable; M12L socket; angled; 5-pole; Length: 10 m
 <b>Item No.: 756-3512/050-100</b> Power cable; M12L socket; angled; 5-pole; Length: 10 m	 <b>Item No.: 756-3502/050-150</b> Power cable; M12L socket; angled; 5-pole; Length: 15 m	 <b>Item No.: 756-3512/050-150</b> Power cable; M12L socket; angled; 5-pole; Length: 15 m	 <b>Item No.: 756-3502/050-020</b> Power cable; M12L socket; angled; 5-pole; Length: 2 m
 <b>Item No.: 756-3512/050-020</b> Power cable; M12L socket; angled; 5-pole; Length: 2 m	 <b>Item No.: 756-3502/050-050</b> Power cable; M12L socket; angled; 5-pole; Length: 5 m	 <b>Item No.: 756-3512/050-050</b> Power cable; M12L socket; angled; 5-pole; Length: 5 m	 <b>Item No.: 756-3502/050-075</b> Power cable; M12L socket; angled; 5-pole; Length: 7.5 m
 <b>Item No.: 756-3512/050-075</b> Power cable; M12L socket; angled; 5-pole; Length: 7.5 m	 <b>Item No.: 756-3506/050-003</b> Power cable; M12L socket; angled; M12L plug; angled; 5-pole; Length: 0.3 m	 <b>Item No.: 756-3506/050-005</b> Power cable; M12L socket; angled; M12L plug; angled; 5-pole; Length: 0.5 m	 <b>Item No.: 756-3516/050-005</b> Power cable; M12L socket; angled; M12L plug; angled; 5-pole; Length: 0.5 m
 <b>Item No.: 756-3506/050-010</b> Power cable; M12L socket; angled; M12L plug; angled; 5-pole; Length: 1 m	 <b>Item No.: 756-3516/050-010</b> Power cable; M12L socket; angled; M12L plug; angled; 5-pole; Length: 1 m	 <b>Item No.: 756-3506/050-100</b> Power cable; M12L socket; angled; M12L plug; angled; 5-pole; Length: 10 m	 <b>Item No.: 756-3516/050-100</b> Power cable; M12L socket; angled; M12L plug; angled; 5-pole; Length: 10 m
 <b>Item No.: 756-3506/050-150</b> Power cable; M12L socket; angled; M12L plug; angled; 5-pole; Length: 15 m	 <b>Item No.: 756-3506/050-020</b> Power cable; M12L socket; angled; M12L plug; angled; 5-pole; Length: 2 m	 <b>Item No.: 756-3516/050-020</b> Power cable; M12L socket; angled; M12L plug; angled; 5-pole; Length: 2 m	 <b>Item No.: 756-3516/050-200</b> Power cable; M12L socket; angled; M12L plug; angled; 5-pole; Length: 20 m
 <b>Item No.: 756-3516/050-400</b> Power cable; M12L socket; angled; M12L plug; angled; 5-pole; Length: 40 m	 <b>Item No.: 756-3506/050-050</b> Power cable; M12L socket; angled; M12L plug; angled; 5-pole; Length: 5 m	 <b>Item No.: 756-3516/050-050</b> Power cable; M12L socket; angled; M12L plug; angled; 5-pole; Length: 5 m	 <b>Item No.: 756-3506/050-075</b> Power cable; M12L socket; angled; M12L plug; angled; 5-pole; Length: 7.5 m
 <b>Item No.: 756-3516/050-075</b> Power cable; M12L socket; angled; M12L plug; angled; 5-pole; Length: 7.5 m	 <b>Item No.: 756-3501/050-100</b> Power cable; M12L socket; straight; 5-pole; Length: 10 m	 <b>Item No.: 756-3511/050-100</b> Power cable; M12L socket; straight; 5-pole; Length: 10 m	 <b>Item No.: 756-3501/050-150</b> Power cable; M12L socket; straight; 5-pole; Length: 15 m
 <b>Item No.: 756-3511/050-150</b> Power cable; M12L socket; straight; 5-pole; Length: 15 m	 <b>Item No.: 756-3501/050-020</b> Power cable; M12L socket; straight; 5-pole; Length: 2 m	 <b>Item No.: 756-3511/050-020</b> Power cable; M12L socket; straight; 5-pole; Length: 2 m	 <b>Item No.: 756-3501/050-050</b> Power cable; M12L socket; straight; 5-pole; Length: 5 m
 <b>Item No.: 756-3511/050-050</b> Power cable; M12L socket; straight; 5-pole; Length: 5 m	 <b>Item No.: 756-3501/050-075</b> Power cable; M12L socket; straight; 5-pole; Length: 7.5 m	 <b>Item No.: 756-3511/050-075</b> Power cable; M12L socket; straight; 5-pole; Length: 7.5 m	 <b>Item No.: 756-3505/050-003</b> Power cable; M12L socket; straight; M12L plug; straight; 5-pole; Length: 0.3 m
 <b>Item No.: 756-3505/050-005</b> Power cable; M12L socket; straight; M12L plug; straight; 5-pole; Length: 0.5 m	 <b>Item No.: 756-3515/050-005</b> Power cable; M12L socket; straight; M12L plug; straight; 5-pole; Length: 0.5 m	 <b>Item No.: 756-3505/050-010</b> Power cable; M12L socket; straight; M12L plug; straight; 5-pole; Length: 1 m	 <b>Item No.: 756-3515/050-010</b> Power cable; M12L socket; straight; M12L plug; straight; 5-pole; Length: 1 m
 <b>Item No.: 756-3505/050-100</b> Power cable; M12L socket; straight; M12L plug; straight; 5-pole; Length: 10 m	 <b>Item No.: 756-3515/050-100</b> Power cable; M12L socket; straight; M12L plug; straight; 5-pole; Length: 10 m	 <b>Item No.: 756-3505/050-150</b> Power cable; M12L socket; straight; M12L plug; straight; 5-pole; Length: 15 m	 <b>Item No.: 756-3505/050-020</b> Power cable; M12L socket; straight; M12L plug; straight; 5-pole; Length: 2 m

1.2.1.6 Power cable



**Item No.: 756-3515/050-020**

Power cable; M12L socket; straight; M12L plug; straight; 5-pole; Length: 2 m

**Item No.: 756-3515/050-200**

Power cable; M12L socket; straight; M12L plug; straight; 5-pole; Length: 20 m

**Item No.: 756-3515/050-300**

Power cable; M12L socket; straight; M12L plug; straight; 5-pole; Length: 30 m

**Item No.: 756-3515/050-400**

Power cable; M12L socket; straight; M12L plug; straight; 5-pole; Length: 40 m



**Item No.: 756-3505/050-050**

Power cable; M12L socket; straight; M12L plug; straight; 5-pole; Length: 5 m

**Item No.: 756-3515/050-050**

Power cable; M12L socket; straight; M12L plug; straight; 5-pole; Length: 5 m

**Item No.: 756-3505/050-075**

Power cable; M12L socket; straight; M12L plug; straight; 5-pole; Length: 7.5 m

**Item No.: 756-3515/050-075**

Power cable; M12L socket; straight; M12L plug; straight; 5-pole; Length: 7.5 m

1.2.1.7 Sensor/actuator cable



**Item No.: 756-5312/040-015**

Sensor/Actuator cable; M12A plug; angled; 4-pole; Length: 1.5 m

**Item No.: 756-5312/040-100**

Sensor/Actuator cable; M12A plug; angled; 4-pole; Length: 10 m

**Item No.: 756-5312/040-050**

Sensor/Actuator cable; M12A plug; angled; 4-pole; Length: 5 m

**Item No.: 756-5311/040-015**

Sensor/Actuator cable; M12A plug; straight; 4-pole; Length: 1.5 m



**Item No.: 756-5311/040-100**

Sensor/Actuator cable; M12A plug; straight; 4-pole; Length: 10 m

**Item No.: 756-5311/040-050**

Sensor/Actuator cable; M12A plug; straight; 4-pole; Length: 5 m

**Item No.: 756-5404/040-010**

Sensor/Actuator cable; M12A socket; straight; M12A plug; angled; 4-pole; Length: 1 m

**Item No.: 756-5404/040-020**

Sensor/Actuator cable; M12A socket; angled; M12A plug; angled; 4-pole; Length: 2 m



**Item No.: 756-5403/040-010**

Sensor/Actuator cable; M12A socket; angled; M12A plug; straight; 4-pole; Length: 1 m

**Item No.: 756-5403/040-020**

Sensor/Actuator cable; M12A socket; angled; M12A plug; straight; 4-pole; Length: 2 m

**Item No.: 756-5402/040-010**

Sensor/Actuator cable; M12A socket; straight; M12A plug; angled; 4-pole; Length: 1 m

**Item No.: 756-5402/040-020**

Sensor/Actuator cable; M12A socket; straight; M12A plug; angled; 4-pole; Length: 2 m



**Item No.: 756-5401/040-010**

Sensor/Actuator cable; M12A socket; straight; M12A plug; straight; 4-pole; Length: 1 m

**Item No.: 756-5401/040-020**

Sensor/Actuator cable; M12A socket; straight; M12A plug; straight; 4-pole; Length: 2 m

**Item No.: 756-5510/040-010**

Sensor/Actuator cable; M8 socket; angled; M12A plug; angled; 4-pole; Length: 1 m

**Item No.: 756-5510/040-020**

Sensor/Actuator cable; M8 socket; angled; M12A plug; angled; 4-pole; Length: 2 m



**Item No.: 756-5509/040-010**

Sensor/Actuator cable; M8 socket; angled; M12A plug; straight; 4-pole; Length: 1 m

**Item No.: 756-5509/040-020**

Sensor/Actuator cable; M8 socket; angled; M12A plug; straight; 4-pole; Length: 2 m

**Item No.: 756-5508/040-010**

Sensor/Actuator cable; M8 socket; straight; M12A plug; angled; 4-pole; Length: 1 m

**Item No.: 756-5508/040-020**

Sensor/Actuator cable; M8 socket; straight; M12A plug; angled; 4-pole; Length: 2 m



**Item No.: 756-5507/040-010**

Sensor/Actuator cable; M8 socket; straight; M12A plug; straight; 4-pole; Length: 1 m

**Item No.: 756-5507/040-020**

Sensor/Actuator cable; M8 socket; straight; M12A plug; straight; 4-pole; Length: 2 m