

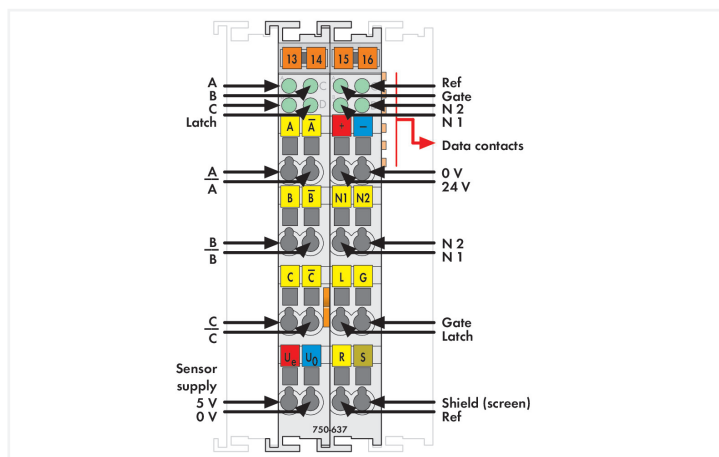

Color: ■ light gray

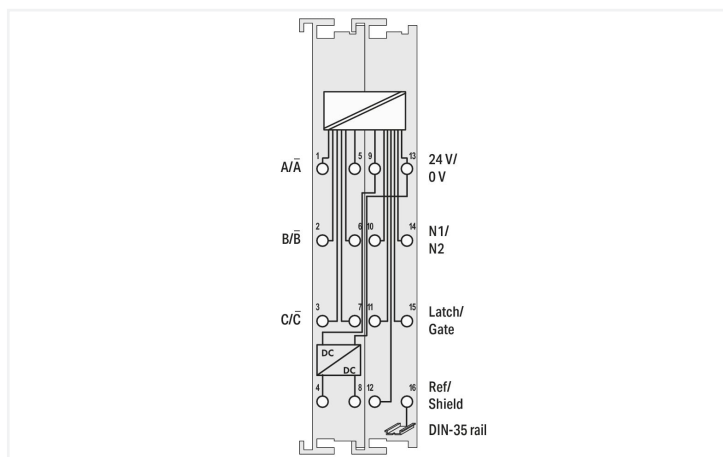
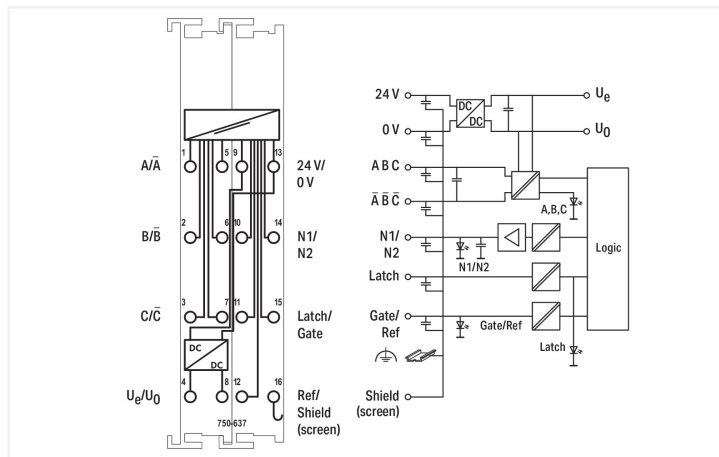

This module is an interface for any incremental encoder with standard connections. A counter with a quadrature decoder as well as a latch for the zero impulse can be read or enabled by the controller. The module's control can set the counter. Depending on the operating mode, the counter value is added to the latch register on a positive edge at the "C" or "Latch" input. The rate (increments/ms) is automatically acquired and can also be transmitted to the controller as an alternative to the latch value. A counter lock-out is possible using the "Gate" input. Input "Ref" can be used to activate the initial point "C" function. The cam outputs N1 and N2 indicate whether the counter value is within a defined range of values. The range can be adjusted. The module must be powered using an external 24 VDC power supply, from which power to the transmitter (U_i , U_0) can also be derived. The shield directly connects to the DIN-rail.

Technical data	
Counter depth	32 bits
Encoder connection	A; /A; B; /B; C; /C (RS-422 inputs)
Supply current (encoder) max.	300 mA
Zero impulse (latch)	32 bits
Quadrature decoder	4x evaluation
Input current (typ.)	Latch 5 mA, Gate 7 mA, Ref. 7 mA
Output current per channel	0.5 A
Output current	short-circuit-protected
Output voltage	24 VDC
Voltage range for signal (0)	U_{ABC} = RS-422; Latch, gate, ref.: -3 ... +5 VDC
Voltage range for signal (1)	U_{ABC} = RS-422; Latch, gate, ref.: 15 ... 30 VDC
Data width	1 x 32-bit data 2 x 8-bit control/status
Limit frequency	250 kHz
Commands	Reading, setting, activating
Supply voltage (system)	5 VDC; via data contacts
Current consumption (5 V system supply)	110 mA

Technical data

Current consumption, field supply (module with no external load)	35 mA
Isolation	500 V system/field
Indicators	LED (A-D/A-D) green: A, C, B, Latch, Gate, N1, Ref, N2

Connection data

Connection technology: inputs/outputs	16 x CAGE CLAMP®
Connectable conductor materials	Copper
Connection type 1	Inputs/outputs
Solid conductor	0.08 ... 2.5 mm ² / 28 ... 14 AWG
Fine-stranded conductor	0.08 ... 2.5 mm ² / 28 ... 14 AWG
Strip length	8 ... 9 mm / 0.31 ... 0.35 inches

Physical data

Width	24 mm / 0.945 inches
Height	100 mm / 3.937 inches
Depth	69.8 mm / 2.748 inches
Depth from upper-edge of DIN-rail	62.6 mm / 2.465 inches

Mechanical data

Mounting type	DIN-35 rail
---------------	-------------

Material data

Color	light gray
Housing material	Polycarbonate; polyamide 6.6
Fire load	2.242 MJ
Weight	101.4 g
Conformity marking	CE

Environmental requirements

Ambient temperature (operation)	0 ... +55 °C
Ambient temperature (storage)	-40 ... +85 °C
Protection type	IP20
Pollution degree	2 per IEC 61131-2
Operating altitude	0 ... 2000 m / 0 ... 6562 ft
Mounting position	Horizontal left, horizontal right, horizontal top, horizontal bottom, vertical top and vertical bottom
Relative humidity (without condensation)	95 %
Vibration resistance	4g per IEC 60068-2-6
Shock resistance	15g per IEC 60068-2-27
EMC immunity to interference	per EN 61000-6-2, marine applications
EMC emission of interference	per EN 61000-6-4, marine applications
Exposure to pollutants	per IEC 60068-2-42 and IEC 60068-2-43
Permissible H ₂ S contaminant concentration at a relative humidity 75 %	10 ppm
Permissible SO ₂ contaminant concentration at a relative humidity 75 %	25 ppm

Commercial data

Product Group	15 (I/O System)
eCl@ss 10.0	27-24-26-05
eCl@ss 9.0	27-24-26-05
ETIM 9.0	EC001601
ETIM 8.0	EC001601
PU (SPU)	1 pcs
Packaging type	Box
Country of origin	DE
GTIN	4045454801021
Customs tariff number	85389099990

Environmental Product Compliance

CAS-No.	1303-86-2 1317-36-8 25550-51-0 7439-92-1
REACH Candidate List Substance	4-Methyl-1,2-cyclohexanedicarboxylic anhydride Diboron trioxide Lead Lead monoxide
RoHS Compliance Status	Compliant,With Exemption
RoHS Exemption	6(c) 7(a) 7(c)-I 7(c)-II
SCIP notification number (Austria)	21abc064-4481-4f3a-b319-37091b2db5e0
SCIP notification number (Belgium)	2a0f46b2-16c0-4e75-b053-30768c6d9e4c
SCIP notification number (Bulgaria)	84adf12d-41a6-4481-af68-a4529d9ab027
SCIP notification number (Czech Republic)	014c64a8-1c70-4a4d-be8c-a7ee71ad0ddf
SCIP notification number (Denmark)	f048682f-be69-470d-ad61-aa50490d02dd
SCIP notification number (Finland)	2bd732f0-fe94-4f32-9677-0044c8d38149
SCIP notification number (France)	ee9540ee-3ebd-4d00-a9cd-b34e526b00cb
SCIP notification number (Germany)	853a9472-274c-4c1d-a275-ef4972a830dc
SCIP notification number (Hungary)	6effe214-5bd5-48a1-b799-91b0d9c6a930
SCIP notification number (Italy)	0ed1d04a-cdb1-4bc9-9816-eec5b64123a2
SCIP notification number (Netherlands)	de7e8d99-55c4-442b-add9-7774e8b8879a
SCIP notification number (Poland)	0c7a0fc6-787b-4396-858d-b621871abddf
SCIP notification number (Romania)	7410e3da-9206-4918-95df-db13442489ce
SCIP notification number (Sweden)	06aa91b5-963d-4796-a091-9d78c4315d29

Approvals / Certificates

General approvals



Approval	Standard	Certificate Name
EAC GZO Almaty Standart	TP TC 020/2011	EAC CoC 03083
KC National Radio Research Agency	Article 58-2, Clause 3	MSIP-REM-W43-DAM750
UL Underwriters Laboratories Inc. (ORDINARY LOCATIONS)	UL 508	E175199

Declarations of conformity and manufacturer's declarations

Approval	Standard	Certificate Name
EU-Declaration of Conformity WAGO GmbH & Co. KG	-	-
UK-Declaration of Conformity WAGO GmbH & Co. KG	-	-

Approvals for marine applications



Approval	Standard	Certificate Name
ABS American Bureau of Shipping	-	22-2219060
BSH Bundesamt fuer Seeschifffahrt und Hydrographie	-	1104
BV Bureau Veritas S.A.	-	30389/C0 BV
DNV DNV GL SE	DNV-CG-0339, Aug. 2021	TAA0000194
KR Korean Register of Shipping	-	KR HMB05880-AC001
LR Lloyds Register EMEA	-	LR22180952TA
PRS Polski Rejestr Statków	-	TE/1101/880590/23
RINA RINA Germany GmbH	-	ELE343521XG001

Approvals for hazardous areas



Approval	Standard	Certificate Name
ATEX TUEV Nord Cert GmbH	EN 60079-0	TUEV14ATEX148929X (II 3 G Ex ec IIC T4 Gc)
CCCEX CQST/CNEx	CNCA-C23-01	2020312310000213 (Ex ec IIC T4 Gc)
IECEX TUEV Nord Cert GmbH	IEC 60079-0	IECEX TUN 14.0035 X (Ex ec IIC T4 Gc)
INMETRO TUV Rheinland do Brasil Ltda.	IEC 60079-0	TUV 12.1297 X
UKEx WAGO GmbH & Co. KG	EN 60079-0	UKCA_WA GO22UKEX003X_ec
UL Underwriters Laboratories Inc. (HAZARDOUS LOCATIONS)	UL 121201	E198726

Downloads

Environmental Product Compliance

Compliance Search
Environmental Product Compliance 750-637 ↓

Documentation

Manual			
Product Manual Incremental encoder interface	V 1.6.1 07.07.2021	pdf 3275.85 KB	↓
System Manual Series 750/753			↓

System Description			
750/753 Series I/O-System – General Product Information		pdf 953.35 KB	↓
Overview on WAGO-I/O-SYSTEM 750 approvals		pdf 770.48 KB	↓

Bid Text			
750-637	09.10.2017	doc 28.00 KB	↓
750-637	19.02.2019	xml 5.73 KB	↓

Instruction Leaflet			
CCC Ex (Additional information)	26.04.2023	pdf 159.76 KB	↓

CAD/CAE-Data

CAD data

2D/3D Models 750-637

CAE data

EPLAN Data Portal 750-637

WSCAD Universe 750-637

ZUKEN Portal 750-637

Device Files

Device Driver

WAGO USB Service Kabel Treiber / Serie 750 und 857	6.5.3.0 10.09.2014	zip 4721.96 KB	
--	-----------------------	-------------------	--

1 Compatible Products

1.1 Optional Accessories

1.1.1 DIN-rail

1.1.1.1 Mounting accessories



Item No.: 210-196
Aluminum carrier rail; 35 x 8.2 mm; 1.6 mm thick; 2 m long; unslotted; similar to EN 60715; silver-colored



Item No.: 210-198
Copper carrier rail; 35 x 15 mm; 2.3 mm thick; 2 m long; unslotted; according to EN 60715; copper-colored



Item No.: 210-508
Steel carrier rail; 35 x 15 mm; 1.5 mm thick; 2 m long; slotted; galvanized; similar to EN 60715; silver-colored



Item No.: 210-197
Steel carrier rail; 35 x 15 mm; 1.5 mm thick; 2 m long; slotted; similar to EN 60715; silver-colored



Item No.: 210-506
Steel carrier rail; 35 x 15 mm; 1.5 mm thick; 2 m long; unslotted; galvanized; similar to EN 60715; silver-colored



Item No.: 210-114
Steel carrier rail; 35 x 15 mm; 1.5 mm thick; 2 m long; unslotted; similar to EN 60715; silver-colored



Item No.: 210-118
Steel carrier rail; 35 x 15 mm; 2.3 mm thick; 2 m long; unslotted; according to EN 60715; silver-colored



Item No.: 210-115
Steel carrier rail; 35 x 7.5 mm; 1 mm thick; 2 m long; slotted; according to EN 60715; "Hole width 18 mm; silver-colored



Item No.: 210-112
Steel carrier rail; 35 x 7.5 mm; 1 mm thick; 2 m long; slotted; according to EN 60715; "Hole width 25 mm; silver-colored



Item No.: 210-504
Steel carrier rail; 35 x 7.5 mm; 1 mm thick; 2 m long; slotted; galvanized; according to EN 60715; silver-colored



Item No.: 210-113
Steel carrier rail; 35 x 7.5 mm; 1 mm thick; 2 m long; unslotted; according to EN 60715; silver-colored



Item No.: 210-505
Steel carrier rail; 35 x 7.5 mm; 1 mm thick; 2 m long; unslotted; galvanized; according to EN 60715; silver-colored











1.1.2 Marking

1.1.2.1 Group marker carrier



Item No.: 750-106
Group marker carrier

1.1.2.2 Marker

 <p>Item No.: 750-100 Marker card; as a DIN A4 sheet; plain</p>	<p>Item No.: 2009-145/000-006 Mini-WSB Inline; for Smart Printer; 1700 pieces on roll; stretchable 5 - 5.2 mm; plain; snap-on type; blue</p>	<p>Item No.: 2009-145/000-007 Mini-WSB Inline; for Smart Printer; 1700 pieces on roll; stretchable 5 - 5.2 mm; plain; snap-on type; gray</p>	<p>Item No.: 2009-145/000-023 Mini-WSB Inline; for Smart Printer; 1700 pieces on roll; stretchable 5 - 5.2 mm; plain; snap-on type; green</p>
<p>Item No.: 2009-145/000-012 Mini-WSB Inline; for Smart Printer; 1700 pieces on roll; stretchable 5 - 5.2 mm; plain; snap-on type; orange</p>	<p>Item No.: 2009-145/000-005 Mini-WSB Inline; for Smart Printer; 1700 pieces on roll; stretchable 5 - 5.2 mm; plain; snap-on type; red</p>	<p>Item No.: 2009-145/000-024 Mini-WSB Inline; for Smart Printer; 1700 pieces on roll; stretchable 5 - 5.2 mm; plain; snap-on type; violet</p>	<p>Item No.: 2009-145 Mini-WSB Inline; for Smart Printer; 1700 pieces on roll; stretchable 5 - 5.2 mm; plain; snap-on type; white</p>
<p>Item No.: 2009-145/000-002 Mini-WSB Inline; for Smart Printer; 1700 pieces on roll; stretchable 5 - 5.2 mm; plain; snap-on type; yellow</p>	 <p>Item No.: 248-501/000-006 Mini-WSB marking card; as card; not stretchable; plain; snap-on type; blue</p>	 <p>Item No.: 248-501/000-007 Mini-WSB marking card; as card; not stretchable; plain; snap-on type; gray</p>	 <p>Item No.: 248-501/000-023 Mini-WSB marking card; as card; not stretchable; plain; snap-on type; green</p>
 <p>Item No.: 248-501/000-017 Mini-WSB marking card; as card; not stretchable; plain; snap-on type; light green</p>	 <p>Item No.: 248-501/000-012 Mini-WSB marking card; as card; not stretchable; plain; snap-on type; orange</p>	 <p>Item No.: 248-501/000-005 Mini-WSB marking card; as card; not stretchable; plain; snap-on type; red</p>	 <p>Item No.: 248-501/000-024 Mini-WSB marking card; as card; not stretchable; plain; snap-on type; violet</p>
 <p>Item No.: 248-501 Mini-WSB marking card; as card; not stretchable; plain; snap-on type; white</p>	 <p>Item No.: 248-501/000-002 Mini-WSB marking card; as card; not stretchable; plain; snap-on type; yellow</p>		

1.1.2.3 Marker carrier

 <p>Item No.: 750-103 Group marker carrier</p>
--

1.1.3 Shield termination

1.1.3.1 Shield clamping saddles

 <p>Item No.: 790-108 Shield clamping saddle; 11 mm wide; diameter of compatible conductor; 3 ... 8 mm</p>	 <p>Item No.: 790-208 Shield clamping saddle; 12.4 mm wide; 3 ... 8 mm</p>	 <p>Item No.: 790-116 Shield clamping saddle; 19 mm wide; diameter of compatible conductor; 7 ... 16 mm</p>	 <p>Item No.: 790-216 Shield clamping saddle; 21.8 mm wide; 6 ... 16 mm</p>
 <p>Item No.: 790-124 Shield clamping saddle; 27 mm wide; diameter of compatible conductor; 6 ... 24 mm</p>	 <p>Item No.: 790-220 Shield clamping saddle; 30 mm wide; 6 ... 20 mm</p>	 <p>Item No.: 790-140 Shield clamping saddle; diameter of compatible conductor</p>	

1.1.4 System enclosure

1.1.4.1 System enclosure



Item No.: 850-825

IP65 enclosure; Aluminium (RAL 7032); WxHxD (160x100x160 mm); 9 x M12, 4 x M20



Item No.: 850-826

IP65 enclosure; Aluminium (RAL 7032); WxHxD (240x100x160 mm); 4 x M20, 4 x M16, 14 x M12 cable grip



Item No.: 850-827

IP65 enclosure; Aluminium (RAL 7032); WxHxD (320x100x160 mm); 4 x M20, 8 x M16, 17 x M12 cable grip



Item No.: 850-828

IP65 enclosure; Aluminium (RAL 7032); WxHxD (480x100x160 mm); 4 x M20, 10 x M16, 35 x M12 cable grip



Item No.: 850-826/002-000

IP65 enclosure; Aluminium (RAL 7035); WxHxD (240x100x160 mm); 4 x M20, 4 x M16, 14 x M12 cable grip



Item No.: 850-827/002-000

IP65 enclosure; Aluminium (RAL 7035); WxHxD (320x100x160 mm); 4 x M20, 8 x M16, 17 x M12 cable grip



Item No.: 850-828/002-000

IP65 enclosure; Aluminium (RAL 7035); WxHxD (480x100x160 mm); 4 x M20, 10 x M16, 35 x M12 cable grip



Item No.: 850-834

IP65 enclosure; Polyester (RAL 7032); WxHxD (164x100x164 mm); 9 x M12, 4 x M20



Item No.: 850-835

IP65 enclosure; Polyester (RAL 7032); WxHxD (244x100x164 mm); 4 x M20, 4 x M16, 14 x M12 cable grip



Item No.: 850-836

IP65 enclosure; Polyester (RAL 7032); WxHxD (324x100x164 mm); 4 x M20, 8 x M16, 17 x M12 cable grip



Item No.: 850-814/002-000

IP65 enclosure; Sheet steel (RAL 7035); WxHxD (200x120x200 mm); without flange plate



Item No.: 850-815/002-000

IP65 enclosure; Sheet steel (RAL 7035); WxHxD (300x120x200 mm); without flange plate



Item No.: 850-816/002-000

IP65 enclosure; Sheet steel (RAL 7035); WxHxD (400x120x200 mm); without flange plate



Item No.: 850-817/002-000

IP65 enclosure; Sheet steel (RAL 7035); WxHxD (600x120x200 mm); without flange plate