

article#	77723-6
article description	CEE-flanged plug angled 32A 3p 6h IP44
description long	CEE-flanged plug angled 32A 3p 6h IP44 housing material: PC/ABS rated current: 32A number of poles: 3 (2P+PE) clock-position: 6h rated voltage/frequency: 200-250V~ / 50+60Hz contacts: brass connection technology: screw terminals IP protection class: IP44
GTIN (EAN)	9003399230653
country of origin	AT
customs number	85366990
net weight	0.200 kg
packaging quantity	5
minimum order quantity	5

ETIM 9.0	EC001319
IEC-amperage	32 A
Voltage according to EN 60309-2	230 V (50+60 Hz) blue
Number of poles	3
Clock hour position	6 h
Identification colour	Blue
Degree of protection (IP)	IP44
Connection system	Screwed terminal
Construction type	Built-up device plug
Angle of plug	Angled
Material	Plastic
Contact material	CuZn
Surface treatment contacts	Untreated

a	90 mm
b	100 mm
c	77 mm
d	85 mm
e	163 mm
f	100 mm
g	5 mm
wire flexible	2,5-6 mm ²
wire solid	2,5-10 mm ²
contact screws	110 Ncm
dismantling length	50 mm
stripping length	12-14 mm
ambient temperature	-25 – 40 °C
temperature resistance	-25 – 80 °C
IK-code *)	IK10

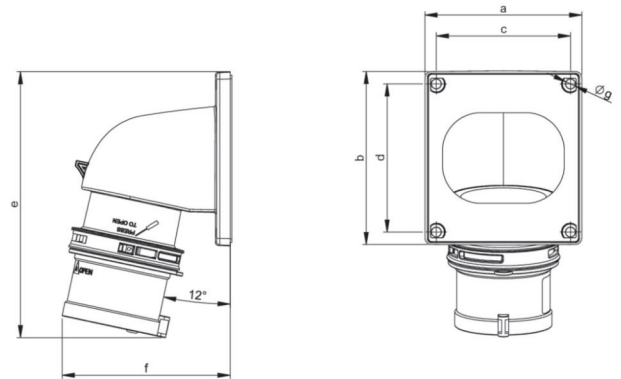

<https://www.pcelectric.at/shop/en/?func=detail&artnr=77723-6>



*) The IK-test is not part of the IEC 60309 standard for industrial plugs and socket-outlets or the IEC 60884 standard for household plugs and socket-outlets. PC Electric GmbH has therefore tested the IK-codes of these products in accordance with IEC 62262 and according to the test method of IEC 60068-2-75 Ehc, with conditioning for 48 hours at 40°C and a relative humidity of 95%.