

Inductive sensor NBN3-F31-E8-V1

- Direct mounting on standard actuators
- Fixed setting

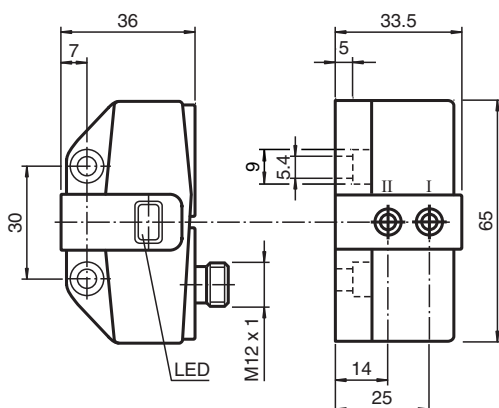

Dimensions



Technical Data

General specifications

Switching function		2 x normally open (NO)
Output type		PNP
Rated operating distance	s_n	3 mm
Installation		flush mountable
Output polarity		DC
Assured operating distance	s_a	0 ... 2.43 mm
Actual operating distance	s_r	2.7 ... 3.3 mm typ.
Reduction factor r_{AI}		0.5
Reduction factor r_{Cu}		0.4
Reduction factor r_{304}		1
Reduction factor r_{St37}		1.2
Output type		3-wire

Nominal ratings

Operating voltage	U_B	10 ... 30 V DC
Switching frequency	f	0 ... 500 Hz

Release date: 2020-03-20 Date of issue: 2020-03-30 Filename: 0477570_eng.pdf

Refer to "General Notes Relating to Pepperl+Fuchs Product Information".

Pepperl+Fuchs Group
www.pepperl-fuchs.com

USA: +1 330 486 0001
fa-info@us.pepperl-fuchs.com

Germany: +49 621 776 1111
fa-info@de.pepperl-fuchs.com

Singapore: +65 6779 9091
fa-info@sg.pepperl-fuchs.com

PEPPERL+FUCHS

Technical Data

Hysteresis	H	typ. 5 %
Reverse polarity protection		all connections
Short-circuit protection		pulsing
Voltage drop	U_d	≤ 3 V
Operating current	I_L	0 ... 100 mA
Off-state current	I_r	0 ... 0.5 mA typ. 0.1 μ A at 25 °C
No-load supply current	I_o	≤ 25 mA
Operating voltage indicator		LED, green
Switching state indicator		LED, yellow
Functional safety related parameters		
MTTF _d		780 a
Mission Time (T _M)		20 a
Diagnostic Coverage (DC)		0 %
Compliance with standards and directives		
Standard conformity		
Standards		EN 60947-5-2:2007 EN 60947-5-2/A1:2012 IEC 60947-5-2:2007 IEC 60947-5-2 AMD 1:2012
Approvals and certificates		
EAC conformity		TR CU 020/2011
UL approval		cULus Listed, General Purpose
CSA approval		cCSAus Listed, General Purpose
CCC approval		CCC approval / marking not required for products rated ≤ 36 V
Ambient conditions		
Ambient temperature		-25 ... 70 °C (-13 ... 158 °F)
Mechanical specifications		
Connection (system side)		4-pin, M12 x 1 connector
Connector housing		metal
Housing material		PBT
Sensing face		PBT
Degree of protection		IP67

Connection

E8-V1

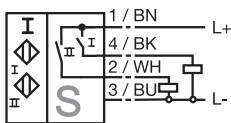

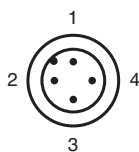

Connection Assignment









Wire colors in accordance with EN 60947-5-2

1	BN	(brown)
2	WH	(white)
3	BU	(blue)
4	BK	(black)

Matching system components

	BT115A	Activator for F31 series
	BT115X	Activator for F31 series

Accessories

	BT65B	Activator for F31 series
	BT115B	Activator for F31 series
	V1-G-2M-PUR	Female cordset, M12, 4-pin, PUR cable
	V1-W-2M-PUR	Female cordset, M12, 4-pin, PUR cable
	BT65A	Activator for F31 series
	BT65X	Activator for F31 series

Release date: 2020-03-20 Date of issue: 2020-03-30 Filename: 047570_eng.pdf

Refer to "General Notes Relating to Pepperl+Fuchs Product Information".

Pepperl+Fuchs Group
www.pepperl-fuchs.com

USA: +1 330 486 0001
fa-info@us.pepperl-fuchs.com

Germany: +49 621 776 1111
fa-info@de.pepperl-fuchs.com

Singapore: +65 6779 9091
fa-info@sg.pepperl-fuchs.com