

# Inductive sensor

## NBN3-F31K-E8-K

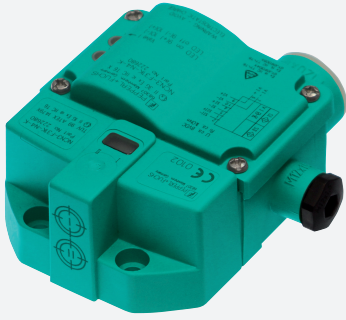

- Direct mounting on standard actuators
- Fixed setting
- LED for power on
- LEDs for switching state of sensor and solenoid valve



### Dimensions

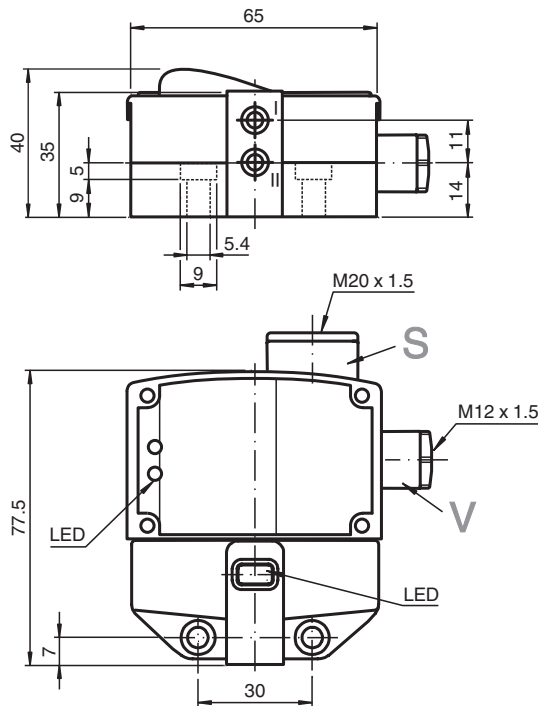

### Technical Data

#### General specifications

Switching function		2 x normally open (NO)
Output type		PNP
Rated operating distance	$s_n$	3 mm
Installation		flush mountable
Output polarity		DC
Assured operating distance	$s_a$	0 ... 2.43 mm
Actual operating distance	$s_r$	2.7 ... 3.3 mm typ.
Reduction factor $r_{AI}$		0.5

Release date: 2020-03-20 Date of issue: 2020-03-30 Filename: 097638\_eng.pdf

Refer to "General Notes Relating to Pepperl+Fuchs Product Information".

Pepperl+Fuchs Group  
www.pepperl-fuchs.com

USA: +1 330 486 0001  
fa-info@us.pepperl-fuchs.com

Germany: +49 621 776 1111  
fa-info@de.pepperl-fuchs.com

Singapore: +65 6779 9091  
fa-info@sg.pepperl-fuchs.com

**PEPPERL+FUCHS**

## Technical Data

Reduction factor $r_{Cu}$		0.4
Reduction factor $r_{304}$		1
Reduction factor $r_{Si37}$		1.2
Output type		4-wire
<b>Nominal ratings</b>		
Operating voltage	$U_B$	10 ... 30 V DC
Switching frequency	$f$	0 ... 500 Hz
Hysteresis	$H$	typ. 5 %
Reverse polarity protection		all connections
Short-circuit protection		pulsing
Voltage drop	$U_d$	$\leq 3$ V
Operating current	$I_L$	0 ... 100 mA
Off-state current	$I_r$	0 ... 0.5 mA typ. 0.1 $\mu$ A
No-load supply current	$I_0$	$\leq 25$ mA
Operating voltage indicator		LED, green
Switching state indicator		LED, yellow
Valve status indicator		LED, yellow
<b>Functional safety related parameters</b>		
MTTF <sub>d</sub>		780 a
Mission Time ( $T_M$ )		20 a
Diagnostic Coverage (DC)		0 %
<b>Valve circuit</b>		
Voltage		max. 32 V DC
Current		max. 240 mA
Short-circuit protection		no
Reverse polarity protection		yes, with reversed output LED is out of function, therefore more power for solenoid valve
<b>Compliance with standards and directives</b>		
Standard conformity		
Standards		EN 60947-5-2:2007 EN 60947-5-2/A1:2012 IEC 60947-5-2:2007 IEC 60947-5-2 AMD 1:2012
<b>Approvals and certificates</b>		
UL approval		cULus Listed, General Purpose
CSA approval		cCSAus Listed, General Purpose
CCC approval		CCC approval / marking not required for products rated $\leq 36$ V
<b>Ambient conditions</b>		
Ambient temperature		-25 ... 70 °C (-13 ... 158 °F)
<b>Mechanical specifications</b>		
Connection (system side)		Cage tension spring terminals
Core cross-section (system side)		1.5/2.5 mm <sup>2</sup> flexible/rigid
Connection (valve side)		Cage tension spring terminals
Core cross-section (valve side)		1.5/2.5 mm <sup>2</sup> flexible/rigid
Housing material		PBT
Sensing face		PBT
Degree of protection		IP67
Tightening torque, housing screws		1 Nm
Tightening torque, cable gland		M20 x 1.5 ; max. 7 Nm M12 x 1.5 ; max. 1.5 Nm

Release date: 2020-03-20 Date of issue: 2020-03-30 Filename: 097638\_eng.pdf

Refer to "General Notes Relating to Pepperl+Fuchs Product Information".

Pepperl+Fuchs Group  
www.pepperl-fuchs.comUSA: +1 330 486 0001  
fa-info@us.pepperl-fuchs.comGermany: +49 621 776 1111  
fa-info@de.pepperl-fuchs.comSingapore: +65 6779 9091  
fa-info@sg.pepperl-fuchs.com



**PEPPERL+FUCHS**

**Connection**

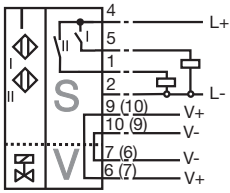

E8-K



**Matching system components**

	<b>BT115A</b>	Activator for F31 series
	<b>BT115X</b>	Activator for F31 series

**Accessories**

	<b>BT65B</b>	Activator for F31 series
	<b>BT115B</b>	Activator for F31 series
	<b>BT65A</b>	Activator for F31 series
	<b>BT65X</b>	Activator for F31 series

Release date: 2020-03-20 Date of issue: 2020-03-30 Filename: 097638\_eng.pdf

## Installation

### Note

The connections to this sensor are sealed with stopping plugs to protect against dirt and moisture. If not all of the connections are used in your application, then seal the remaining stopping plugs on the sensor permanently or check during initial installation and when performing regular maintenance work that the stopping plugs are secure and impermeable. If necessary, tighten the stopping plugs to a torque of 1 Nm.