



Inductive sensor NBN40-L2-Z0-V1

- Sensor head bidirectional and rotatable
- 40 mm non-flush
- 2-wire DC
- Quick mounting bracket



Dimensions

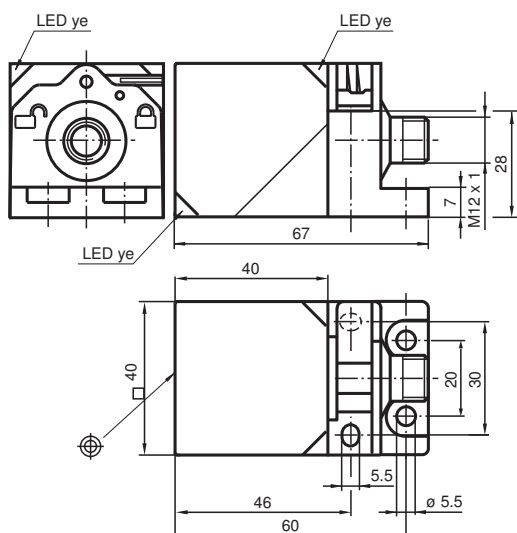

Technical Data

General specifications

Switching function		Normally open (NO)
Output type		Two-wire
Rated operating distance	s_n	40 mm
Installation		non-flush
Output polarity		DC
Assured operating distance	s_a	0 ... 32.4 mm (-25 ... 60 °C (-13 ... 140 °F) 0 ... 30 mm (60 ... 70 °C (140 ... 158 °F)
Actual operating distance	s_r	36 ... 44 mm
Reduction factor r_{Al}		0.33
Reduction factor r_{Cu}		0.31
Reduction factor r_{304}		0.75
Reduction factor r_{Brass}		0.41
Output type		2-wire

Release date: 2020-03-23 Date of issue: 2020-03-30 Filename: 182172_eng.pdf

Refer to "General Notes Relating to Pepperl+Fuchs Product Information".

Pepperl+Fuchs Group
www.pepperl-fuchs.com

USA: +1 330 486 0001
fa-info@us.pepperl-fuchs.com

Germany: +49 621 776 1111
fa-info@de.pepperl-fuchs.com

Singapore: +65 6779 9091
fa-info@sg.pepperl-fuchs.com

PEPPERL+FUCHS

Technical Data

Nominal ratings		
Operating voltage	U_B	5 ... 30 V DC
Switching frequency	f	0 ... 30 Hz
Reverse polarity protection		reverse polarity tolerant
Short-circuit protection		pulsing
Voltage drop	U_d	≤ 5 V
Voltage drop at I_L		
Voltage drop $I_L = 100$ mA, switching element on	U_d	... 5 V
Operating current	I_L	2 ... 100 mA
Off-state current	I_r	0 ... 0.5 mA
Switching state indicator		LED, yellow
Functional safety related parameters		
MTTF _d		977 a
Mission Time (T_M)		20 a
Diagnostic Coverage (DC)		0 %
Compliance with standards and directives		
Standard conformity		
Standards		EN 60947-5-2:2007 EN 60947-5-2/A1:2012 IEC 60947-5-2:2007 IEC 60947-5-2 AMD 1:2012
Approvals and certificates		
UL approval		cULus Listed, General Purpose
CCC approval		CCC approval / marking not required for products rated ≤ 36 V
Ambient conditions		
Ambient temperature		-25 ... 70 °C (-13 ... 158 °F)
Storage temperature		-25 ... 85 °C (-13 ... 185 °F)
Mechanical specifications		
Connection type		Connector plug M12 x 1 , 4-pin
Housing material		PA
Sensing face		PA
Degree of protection		IP69K

Connection

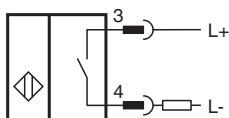



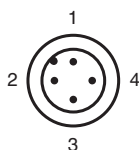

Connection Assignment



Wire colors in accordance with EN 60947-5-2

1	BN	(brown)
2	WH	(white)
3	BU	(blue)
4	BK	(black)

Accessories

	V1-G-2M-PUR	Female cordset, M12, 4-pin, PUR cable
	V1-W-2M-PUR	Female cordset, M12, 4-pin, PUR cable
	MHW 01	Modular mounting bracket
	MH 02-L	Mounting aid

Release date: 2020-03-23 Date of issue: 2020-03-30 Filename: 182172_eng.pdf

Refer to "General Notes Relating to Pepperl+Fuchs Product Information".

Pepperl+Fuchs Group
www.pepperl-fuchs.com

USA: +1 330 486 0001
fa-info@us.pepperl-fuchs.com

Germany: +49 621 776 1111
fa-info@de.pepperl-fuchs.com

Singapore: +65 6779 9091
fa-info@sg.pepperl-fuchs.com